

# SP 4

## ELETTROPOMPE SOMMERSE MULTISTADIO PER POZZI 4"

### APPLICAZIONI

Elettropompe sommerse multistadio per pozzi profondi da 4" (DN 100 mm). Particolarmente adatte per applicazioni civili e industriali, alimentazione getti d'acqua e fontane, impianti antincendio, l'irrigazione in generale e per l'approvvigionamento di acqua pulita.

### APPLICATION

Multistage submersible water pumps for 4" deep wells (DN 100 mm). Particularly suitable for civil and industrial purposes, for sprinkler and food irrigation plants, in fire installations and generally speaking for clean water supplying.

### LIMITI D'IMPIEGO

- Profondità max. di immersione 150 mt
- Temperatura liquido fino a 35°C (per un uso domestico secondo EN 60335-2-41)
- Temperatura max. liquido: 35°C (per altri impieghi)
- Contenuto di sabbia max. 50 g/m<sup>3</sup>
- Partenza /ora 20 max.

### MOTORE

- Motore elettrico ad induzione a 2 poli (n=2850 min<sup>-1</sup>)
- Motore sommerso in bagno d'olio
- Isolamento Classe F
- Protezione IP 68
- Servizio continuo

### MATERIALI MOTORE

- Camicia esterna Acciaio inox AISI 304
- Albero motore Acciaio inox AISI 304
- Supporto superiore Ghisa zincata
- Tenuta meccanica Ceramica/Grafite

### MATERIALI POMPE

- Camicia esterna Acciaio inox AISI 304
- Albero motore Acciaio inox AISI 304
- Stadi Policarbonato
- Giranti Noryl

### OPERATING CONDITIONS

- Max. depth of immersion 150 mt
- Liquid temperature up to 35°C (for home use according to EN 60335-2-41)
- Temperature max. liquid: 35°C (for other uses)
- Sand content max. 50 g/m<sup>3</sup>
- Start/hour 20 max.

### MOTOR

- Two-pole induction motor (n=2850 min<sup>-1</sup>)
- Submersible motor in oil bath
- Class F Insulation
- IP 68 Protection
- Continuous duty

### MOTOR MATERIALS

- External casing Stainless steel AISI 304
- Motor shaft Stainless steel AISI 304
- Upper bracket Zinc plated Cast Iron
- Mechanical seal Ceramic/Graphite

### PUMP MATERIALS

- External casing Stainless steel AISI 304
- Motor shaft Stainless steel AISI 304
- Stages Polycarbonate
- Impellers Noryl

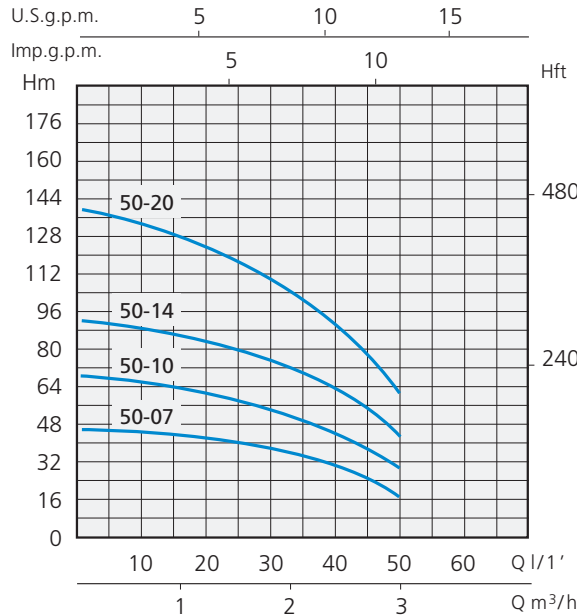

TIPO TYPE	DIMENSIONI mm - DIMENSIONS mm		
	A	B	C
SPM-SP/TR 50-07	346	271	617
SPM-SP/TR 50-10	365	324	689
SPM-SP/TR 50-14	380	394	774
SPM-SP/TR 50-20	405	499	904

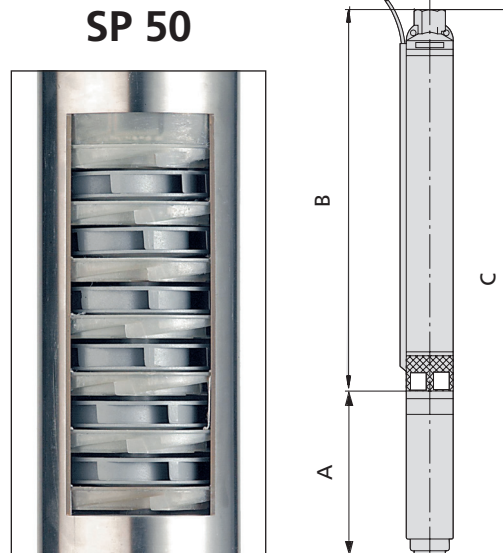

TIPO - TYPE		POTENZA NOMINALE NOMINAL POWER		STADI STAGES	Q = PORTATA - CAPACITY										DNM
Monofase Single-phase	Trifase Three-phase	P2			m³/h	0	0,9	1,2	1,5	1,8	2,1	2,4	2,7	3	
230V-50Hz	400V-50Hz	HP	kW	lt/1'	0	15	20	25	30	35	40	45	50		
Prevalenza manometrica totale in m.C.A. - Total head in meters w.c.															
SPM 50-07	SP/TR 50-07	0,5	0,37	7	H (m)	46	43	42	39	36	33	29	26	22	1" 1/4
SPM 50-10	SP/TR 50-10	0,75	0,55	10		69	65	63	60	55	50	44	37	29	1" 1/4
SPM 50-14	SP/TR 50-14	1	0,75	14		92	86	83	79	74	67	60	52	42	1" 1/4
SPM 50-20	SP/TR 50-20	1,5	1,1	20		139	131	127	120	111	101	90	75	60	1" 1/4

## APPLICAZIONI

Elettropompe sommerse multistadio per pozzi profondi da 4" (DN 100 mm). Particolarmente adatte per applicazioni civili e industriali, alimentazione getti d'acqua e fontane, impianti antincendio, l'irrigazione in generale e per l'approvvigionamento di acqua pulita.

## APPLICATION

Multistage submersible water pumps for 4" deep wells (DN 100 mm). Particularly suitable for civil and industrial purposes, for sprinkler and food irrigation plants, in fire installations and generally speaking for clean water supplying.

## LIMITI D'IMPIEGO

- Profondità max. di immersione 150 mt
- Temperatura liquido fino a 35°C (per un uso domestico secondo EN 60335-2-41)
- Temperatura max. liquido: 35°C (per altri impieghi)
- Contenuto di sabbia max. 50 g/m<sup>3</sup>
- Partenza /ora 20 max.

## MOTORE

- Motore elettrico ad induzione a 2 poli (n=2850 min<sup>-1</sup>)
- Motore sommerso in bagno d'olio
- Isolamento Classe F
- Protezione IP 68
- Servizio continuo

## MATERIALI MOTORE

- Camicia esterna Acciaio inox AISI 304
- Albero motore Acciaio inox AISI 304
- Supporto superiore Ghisa zincata
- Tenuta meccanica Ceramica/Grafite

## MATERIALI POMPE

- Camicia esterna Acciaio inox AISI 304
- Albero motore Acciaio inox AISI 304
- Stadi Policarbonato
- Giranti Noryl

## OPERATING CONDITIONS

- Max. depth of immersion 150 mt
- Liquid temperature up to 35°C (for home use according to EN 60335-2-41)
- Temperature max. liquid: 35°C (for other uses)
- Sand content max. 50 g/m<sup>3</sup>
- Start/hour 20 max.

## MOTOR

- Two-pole induction motor (n=2850 min<sup>-1</sup>)
- Submersible motor in oil bath
- Class F Insulation
- IP 68 Protection
- Continuous duty

## MOTOR MATERIALS

- External casing Stainless steel AISI 304
- Motor shaft Stainless steel AISI 304
- Upper bracket Zinc plated Cast Iron
- Mechanical seal Ceramic/Graphite

## PUMP MATERIALS

- External casing Stainless steel AISI 304
- Motor shaft Stainless steel AISI 304
- Stages Polycarbonate
- Impellers Noryl

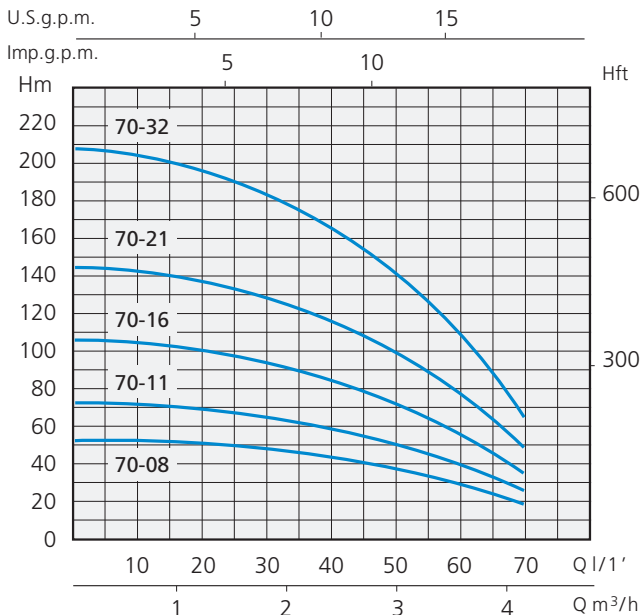

TIPO TYPE	DIMENSIONI mm - DIMENSIONS mm		
	A	B	C
SPM-SP/TR 70-08	365	289	654
SPM-SP/TR 70-11	380	342	722
SPM-SP/TR 70-16	405	430	835
SPM-SP/TR 70-21	440	519	959
SPM-SP/TR 70-32	495	749	1244



## SP 70

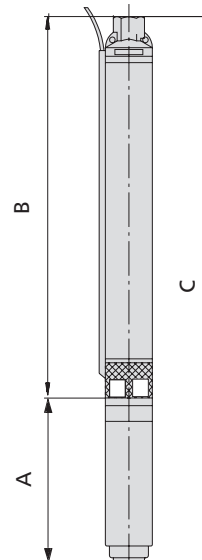

TIPO - TYPE		POTENZA NOMINALE NOMINAL POWER		STADI STAGES	Q = PORTATA - CAPACITY													DNM
Monofase Single-phase	Trifase Three-phase	P2			m <sup>3</sup> /h	0	0,9	1,2	1,5	1,8	2,1	2,4	2,7	3	3,6	4,2		
230V-50Hz	400V-50Hz	HP	kW		lt/1'	0	15	20	25	30	35	40	45	50	60	70		
Prevalenza manometrica totale in m.C.A. - Total head in meters w.c.																		
SPM 70-08	SP/TR 70-08	0,75	0,55	8	H (m)	54	53	51	50	49	46	43	41	38	30	19	1" 1/4	
SPM 70-11	SP/TR 70-11	1	0,75	11		72	71	68	66	64	61	58	54	49	38	26	1" 1/4	
SPM 70-16	SP/TR 70-16	1,5	1,1	16		106	105	101	98	95	89	83	77	70	54	33	1" 1/4	
SPM 70-21	SP/TR 70-21	2	1,5	21		142	141	135	132	127	122	115	108	100	79	49	1" 1/4	
SPM 70-32	SP/TR 70-32	3	2,2	32		208	206	200	194	187	177	165	152	138	104	62	1" 1/4	

# SP 4

## ELETTROPOMPE SOMMERSE MULTISTADIO PER POZZI 4"

### APPLICAZIONI

Elettropompe sommerse multistadio per pozzi profondi da 4" (DN 100 mm). Particolarmente adatte per applicazioni civili e industriali, alimentazione getti d'acqua e fontane, impianti antincendio, l'irrigazione in generale e per l'approvvigionamento di acqua pulita.

### APPLICATION

Multistage submersible water pumps for 4" deep wells (DN 100 mm). Particularly suitable for civil and industrial purposes, for sprinkler and food irrigation plants, in fire installations and generally speaking for clean water supplying.

### LIMITI D'IMPIEGO

- Profondità max. di immersione 150 mt
- Temperatura liquido fino a 35°C (per un uso domestico secondo EN 60335-2-41)
- Temperatura max. liquido: 35°C (per altri impieghi)
- Contenuto di sabbia max. 50 g/m<sup>3</sup>
- Partenza /ora 20 max.

### MOTORE

- Motore elettrico ad induzione a 2 poli (n=2850 min<sup>-1</sup>)
- Motore sommerso in bagno d'olio
- Isolamento Classe F
- Protezione IP 68
- Servizio continuo

### MATERIALI MOTORE

- Camicia esterna Acciaio inox AISI 304
- Albero motore Acciaio inox AISI 304
- Supporto superiore Ghisa zincata
- Tenuta meccanica Ceramica/Grafite

### MATERIALI POMPE

- Camicia esterna Acciaio inox AISI 304
- Albero motore Acciaio inox AISI 304
- Stadi Policarbonato
- Giranti Noryl

### OPERATING CONDITIONS

- Max. depth of immersion 150 mt
- Liquid temperature up to 35°C (for home use according to EN 60335-2-41)
- Temperature max. liquid: 35°C (for other uses)
- Sand content max. 50 g/m<sup>3</sup>
- Start/hour 20 max.

### MOTOR

- Two-pole induction motor (n=2850 min<sup>-1</sup>)
- Submersible motor in oil bath
- Class F Insulation
- IP 68 Protection
- Continuous duty

### MOTOR MATERIALS

- External casing Stainless steel AISI 304
- Motor shaft Stainless steel AISI 304
- Upper bracket Zinc plated Cast Iron
- Mechanical seal Ceramic/Graphite

### PUMP MATERIALS

- External casing Stainless steel AISI 304
- Motor shaft Stainless steel AISI 304
- Stages Polycarbonate
- Impellers Noryl

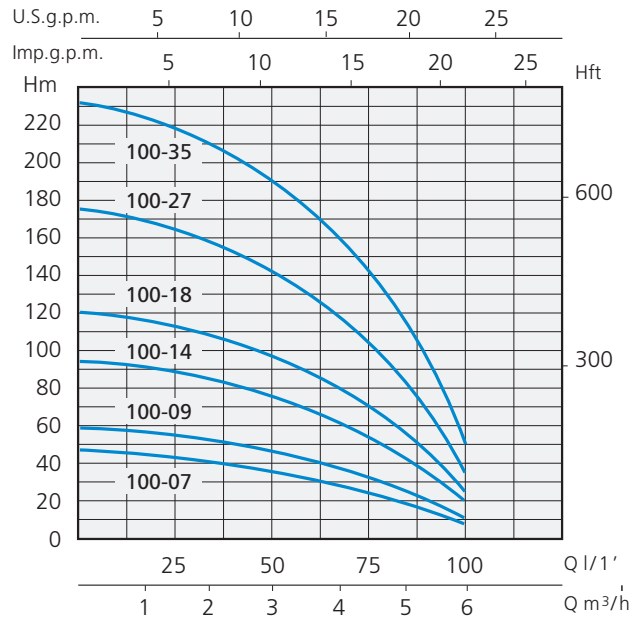

TIPO TYPE	DIMENSIONI mm - DIMENSIONS mm		
	A	B	C
SPM-SP/TR 100-07	365	301	666
SPM-SP/TR 100-09	380	344	724
SPM-SP/TR 100-14	405	452	857
SPM-SP/TR 100-18	440	538	978
SPM-SP/TR 100-27	495	767	1262
SP/TR 100-35	607	934	1541



### SP 100

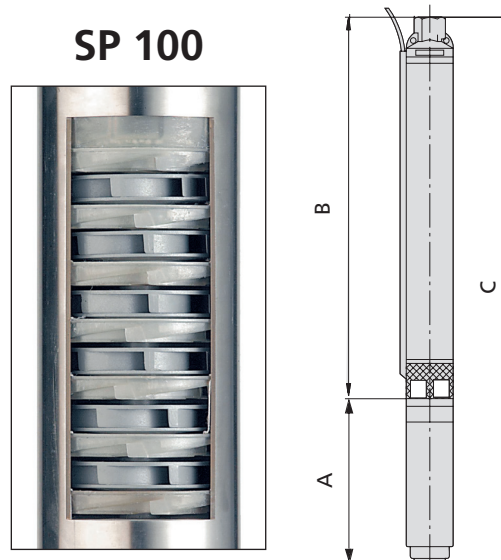

TIPO - TYPE		POTENZA NOMINALE NOMINAL POWER		STADI STAGES	Q = PORTATA - CAPACITY											DNM	
Monofase Single-phase	Trifase Three-phase	P2			m <sup>3</sup> /h	0	1,5	1,8	2,1	2,4	3	3,6	4,2	4,8	5,4		6
230V-50Hz	400V-50Hz	HP	kW	lt/1'	0	25	30	35	40	50	60	70	80	90	100		
Prevalenza manometrica totale in m.C.A. - Total head in meters w.c.																	
SPM 100-07	SP/TR 100-07	0,75	0,55	7	H (m)	46	43	42	41	40	37	33	28	21	13	7	1" 1/4
SPM 100-09	SP/TR 100-09	1	0,75	9		59	55	54	52	51	47	43	37	28	20	10	1" 1/4
SPM 100-14	SP/TR 100-14	1,5	1,1	14		93	87	86	83	81	76	68	58	47	33	20	1" 1/4
SPM 100-18	SP/TR 100-18	2	1,5	18		120	113	111	108	105	98	88	75	60	42	25	1" 1/4
SPM 100-27	SP/TR 100-27	3	2,2	27		175	164	161	157	152	141	127	109	87	61	35	1" 1/4
	SP/TR 100-35	4	3	35		231	217	212	208	202	189	170	149	120	87	50	1" 1/4



# MULTISTAGE SUBMERSIBLE PUMPS FOR 4" WELLS



## APPLICAZIONI

Elettropompe sommerse multistadio per pozzi profondi da 4" (DN 100 mm). Particolarmente adatte per applicazioni civili e industriali, alimentazione getti d'acqua e fontane, impianti antincendio, l'irrigazione in generale e per l'approvvigionamento di acqua pulita.

## APPLICATION

Multistage submersible water pumps for 4" deep wells (DN 100 mm). Particularly suitable for civil and industrial purposes, for sprinkler and food irrigation plants, in fire installations and generally speaking for clean water supplying.

## LIMITI D'IMPIEGO

- Profondità max. di immersione 150 mt
- Temperatura liquido fino a 35°C (per un uso domestico secondo EN 60335-2-41)
- Temperatura max. liquido: 35°C (per altri impieghi)
- Contenuto di sabbia max. 50 g/m<sup>3</sup>
- Partenza /ora 20 max.

## MOTORE

- Motore elettrico ad induzione a 2 poli (n=2850 min<sup>-1</sup>)
- Motore sommerso in bagno d'olio
- Isolamento Classe F
- Protezione IP 68
- Servizio continuo

## MATERIALI MOTORE

- Camicia esterna: Acciaio inox AISI 304
- Albero motore: Acciaio inox AISI 304
- Supporto superiore: Ghisa zincata
- Tenuta meccanica: Ceramica/Grafite

## MATERIALI POMPE

- Camicia esterna: Acciaio inox AISI 304
- Albero motore: Acciaio inox AISI 304
- Stadi: Policarbonato
- Giranti: Noryl

## OPERATING CONDITIONS

- Max. depth of immersion 150 mt
- Liquid temperature up to 35°C (for home use according to EN 60335-2-41)
- Temperature max. liquid: 35°C (for other uses)
- Sand content max. 50 g/m<sup>3</sup>
- Start/hour 20 max.

## MOTOR

- Two-pole induction motor (n=2850 min<sup>-1</sup>)
- Submersible motor in oil bath
- Class F Insulation
- IP 68 Protection
- Continuous duty

## MOTOR MATERIALS

- External casing: Stainless steel AISI 304
- Motor shaft: Stainless steel AISI 304
- Upper bracket: Zinc plated Cast Iron
- Mechanical seal: Ceramic/Graphite

## PUMP MATERIALS

- External casing: Stainless steel AISI 304
- Motor shaft: Stainless steel AISI 304
- Stages: Polycarbonate
- Impellers: Noryl

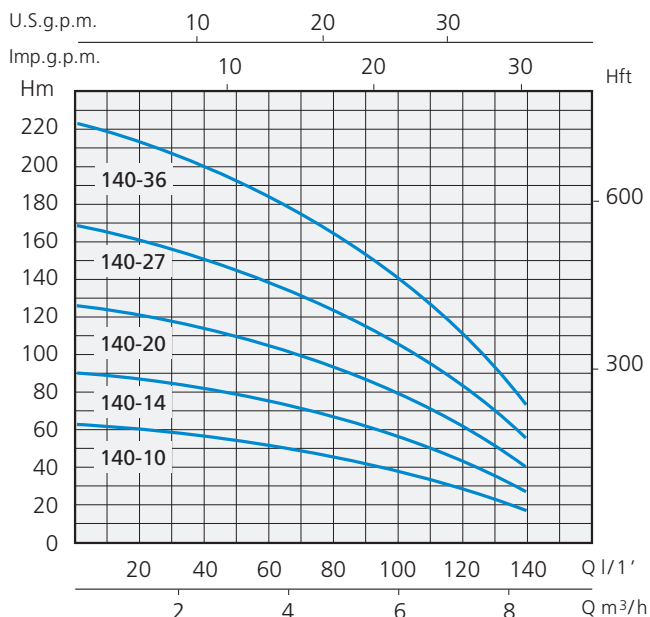

TIPO TYPE	DIMENSIONI mm - DIMENSIONS mm		
	A	B	C
SPM-SP/TR 140-10	405	483	888
SPM-SP/TR 140-14	440	607	1047
SPM-SP/TR 140-20	495	831	1326
SP/TR 140-27	607	1048	1655
SP/TR 140-36	683	1318	2001



## SP 140

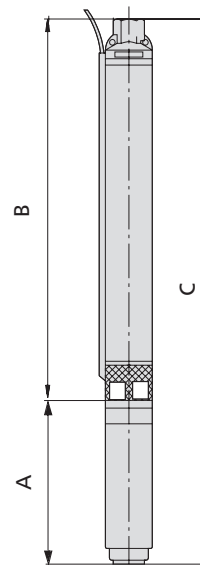

TIPO - TYPE		POTENZA NOMINALE NOMINAL POWER		STADI STAGES	Q = PORTATA - CAPACITY										DNM
Monofase Single-phase	Trifase Three-phase	P2			m <sup>3</sup> /h	0	3	3,6	4,2	4,8	5,4	6	7,2	8,4	
230V-50Hz	400V-50Hz	HP	kW	lt/1'	0	50	60	70	80	90	100	120	140		
Prevalenza manometrica totale in m.C.A. - Total head in meters w.c.															
SPM 140-10	SP/TR 140-10	1,5	1,1	10	H (m)	62	53	51	48	45	41	38	29	18	2"
SPM 140-14	SP/TR 140-14	2	1,5	14		90	77	74	71	68	63	59	46	28	2"
SPM 140-20	SP/TR 140-20	3	2,2	20		125	107	102	97	92	86	80	62	40	2"
	SP/TR 140-27	4	3	27		169	145	139	131	123	115	107	84	55	2"
	SP/TR 140-36	5,5	4	36		221	190	181	173	164	154	143	112	72	2"

# SP 4

## ELETTROPOMPE SOMMERSE MULTISTADIO PER POZZI 4"

### APPLICAZIONI

Elettropompe sommerse multistadio per pozzi profondi da 4" (DN 100 mm). Particolarmente adatte per applicazioni civili e industriali, alimentazione getti d'acqua e fontane, impianti antincendio, l'irrigazione in generale e per l'approvvigionamento di acqua pulita.

### APPLICATION

Multistage submersible water pumps for 4" deep wells (DN 100 mm). Particularly suitable for civil and industrial purposes, for sprinkler and food irrigation plants, in fire installations and generally speaking for clean water supplying.

### LIMITI D'IMPIEGO

- Profondità max. di immersione 150 mt
- Temperatura liquido fino a 35°C (per un uso domestico secondo EN 60335-2-41)
- Temperatura max. liquido: 35°C (per altri impieghi)
- Contenuto di sabbia max. 50 g/m<sup>3</sup>
- Partenza /ora 20 max.

### MOTORE

- Motore elettrico ad induzione a 2 poli (n=2850 min<sup>-1</sup>)
- Motore sommerso in bagno d'olio
- Isolamento Classe F
- Protezione IP 68
- Servizio continuo

### MATERIALI MOTORE

- Camicia esterna: Acciaio inox AISI 304
- Albero motore: Acciaio inox AISI 304
- Supporto superiore: Ghisa zincata
- Tenuta meccanica: Ceramica/Grafite

### MATERIALI POMPE

- Camicia esterna: Acciaio inox AISI 304
- Albero motore: Acciaio inox AISI 304
- Stadi: Policarbonato
- Giranti: Noryl

### OPERATING CONDITIONS

- Max. depth of immersion 150 mt
- Liquid temperature up to 35°C (for home use according to EN 60335-2-41)
- Temperature max. liquid: 35°C (for other uses)
- Sand content max. 50 g/m<sup>3</sup>
- Start/hour 20 max.

### MOTOR

- Two-pole induction motor (n=2850 min<sup>-1</sup>)
- Submersible motor in oil bath
- Class F Insulation
- IP 68 Protection
- Continuous duty

### MOTOR MATERIALS

- External casing: Stainless steel AISI 304
- Motor shaft: Stainless steel AISI 304
- Upper bracket: Zinc plated Cast Iron
- Mechanical seal: Ceramic/Graphite

### PUMP MATERIALS

- External casing: Stainless steel AISI 304
- Motor shaft: Stainless steel AISI 304
- Stages: Polycarbonate
- Impellers: Noryl

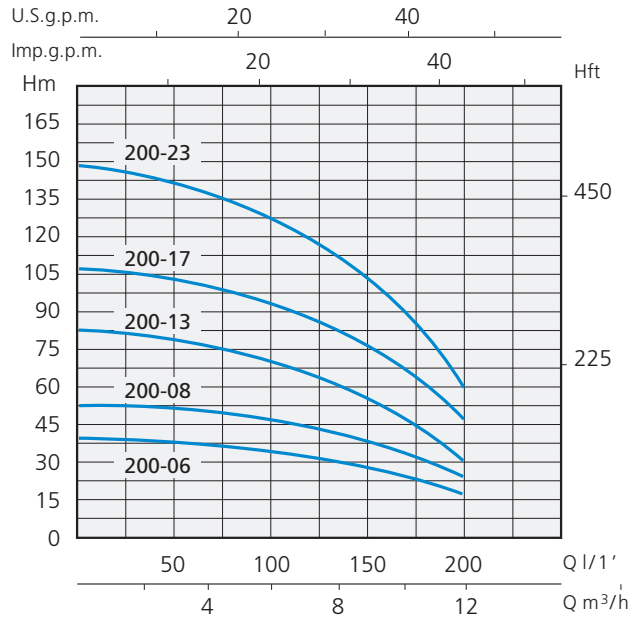

TIPO TYPE	DIMENSIONI mm - DIMENSIONS mm		
	A	B	C
SPM-SP/TR 200-06	405	356	761
SPM-SP/TR 200-08	440	418	858
SPM-SP/TR 200-13	495	573	1068
SP/TR 200-17	607	697	1304
SP/TR 200-23	683	921	1604



### SP 200

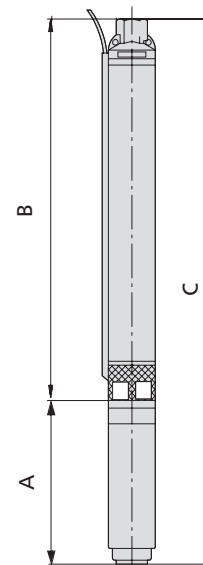

TIPO - TYPE		POTENZA NOMINALE NOMINAL POWER		STADI STAGES	Q = PORTATA - CAPACITY												DNM
Monofase Single-phase	Trifase Three-phase	P2			m³/h	0	3,6	4,2	4,8	5,4	6	7,2	8,4	9,6	10,8	12	
230V-50Hz	400V-50Hz	HP	kW	lt/1'	0	60	70	80	90	100	120	140	160	180	200		
Prevalenza manometrica totale in m.C.A. - Total head in meters w.c.																	
SPM 200-06	SP/TR 200-06	1,5	1,1	6	H (m)	39	38	37	36	35	34	32	29	26	22	17	2"
SPM 200-08	SP/TR 200-08	2	1,5	8		52	51	50	48	47	46	43	39	35	29	24	2"
SPM 200-13	SP/TR 200-13	3	2,2	13		82	80	78	75	73	71	66	59	50	40	30	2"
	SP/TR 200-17	4	3	17		108	106	102	98	96	94	87	79	70	58	46	2"
	SP/TR 200-23	5,5	4	23		148	144	140	134	131	127	118	108	95	79	60	2"

## APPLICAZIONI

Elettropompe sommerse multistadio per pozzi profondi da 4" (DN 100 mm). Particolarmente adatte per applicazioni civili e industriali, alimentazione getti d'acqua e fontane, impianti antincendio, l'irrigazione in generale e per l'approvvigionamento di acqua pulita.

## APPLICATION

Multistage submersible water pumps for 4" deep wells (DN 100 mm). Particularly suitable for civil and industrial purposes, for sprinkler and food irrigation plants, in fire installations and generally speaking for clean water supplying.

## LIMITI D'IMPIEGO

- Profondità max. di immersione 150 mt
- Temperatura liquido fino a 35°C (per un uso domestico secondo EN 60335-2-41) Temperatura max. liquido: 35°C (per altri impieghi)
- Contenuto di sabbia max. 50 g/m<sup>3</sup>
- Partenza /ora 20 max.

## MOTORE

- Motore elettrico ad induzione a 2 poli (n=2850 min<sup>-1</sup>)
- Motore sommerso in bagno d'olio
- Isolamento Classe F
- Protezione IP 68
- Servizio continuo

## MATERIALI MOTORE

- Camicia esterna Acciaio inox AISI 304
- Albero motore Acciaio inox AISI 304
- Supporto superiore Ghisa zincata
- Tenuta meccanica Ceramica/Grafite

## MATERIALI POMPE

- Camicia esterna Acciaio inox AISI 304
- Albero motore Acciaio inox AISI 304
- Stadi Policarbonato
- Giranti Noryl

## OPERATING CONDITIONS

- Max. depth of immersion 150 mt
- Liquid temperature up to 35°C (for home use according to EN 60335-2-41) Temperature max. liquid: 35°C (for other uses)
- Sand content max. 50 g/m<sup>3</sup>
- Start/hour 20 max.

## MOTOR

- Two-pole induction motor (n=2850 min<sup>-1</sup>)
- Submersible motor in oil bath
- Class F Insulation
- IP 68 Protection
- Continuous duty

## MOTOR MATERIALS

- External casing Stainless steel AISI 304
- Motor shaft Stainless steel AISI 304
- Upper bracket Zinc plated Cast Iron
- Mechanical seal Ceramic/Graphite

## PUMP MATERIALS

- External casing Stainless steel AISI 304
- Motor shaft Stainless steel AISI 304
- Stages Polycarbonate
- Impellers Noryl

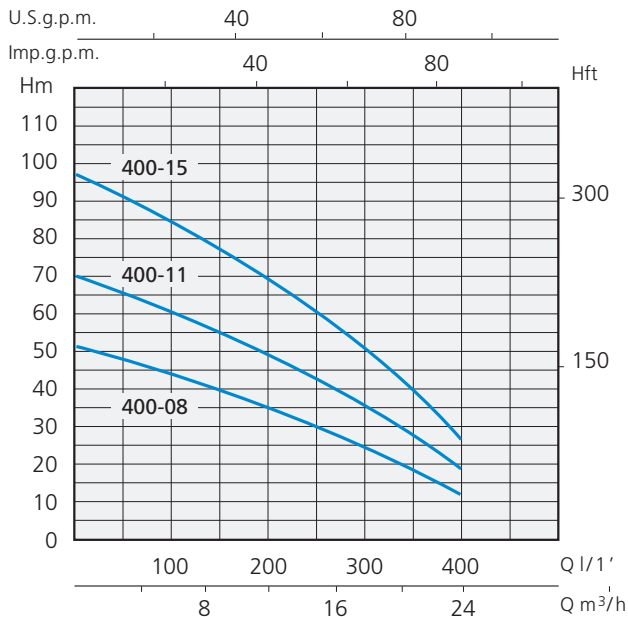

TIPO TYPE	DIMENSIONI mm - DIMENSIONS mm		
	A	B	C
SPM-SP/TR 400-08	495	676	1171
SP/TR 400-11	607	880	1487
SP/TR 400-15	683	1149	1832



## SP 400

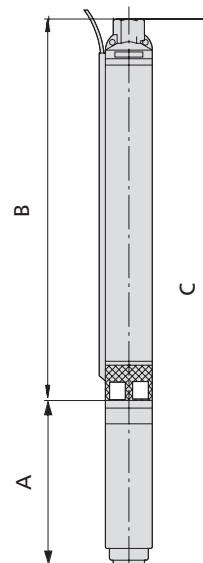

TIPO - TYPE		POTENZA NOMINALE NOMINAL POWER		STADI STAGES	Q = PORTATA - CAPACITY											DNM	
Monofase Single-phase	Trifase Three-phase	P2			m <sup>3</sup> /h	0	8,4	9,6	12	14,4	16	17	18	22	23		24
		HP	kW	lt/1'	0	140	160	200	240	260	280	300	360	380	400		
230V-50Hz	400V-50Hz	Prevalenza manometrica totale in m.C.A. - Total head in meters w.c.															
SPM 400-08	SP/TR 400-08	3	2,2	8	H (m)	51	41	39	35	31	29	27	24	17	14	12	2"
	SP/TR 400-11	4	3	11		70	57	54	49	44	41	38	34	24	21	18	2"
	SP/TR 400-15	5,5	4	15		97	79	76	69	63	58	54	50	36	32	27	2"

## **ОФИЦИАЛЬНЫЙ ДИЛЕР В УКРАИНЕ:**

[storgom.ua](http://storgom.ua)

## **ГРАФИК РАБОТЫ:**

Пн. – Пт.: с 8:30 по 18:30

Сб.: с 09:00 по 16:00

Вс.: с 10:00 по 16:00

## **КОНТАКТЫ:**

+38 (044) 360-46-77

+38 (066) 77-395-77

+38 (097) 77-236-77

+38 (093) 360-46-77

Детальное описание товара:

<https://storgom.ua/product/pogruzhnoi-skvazhinnyi-nasos-speroni-spm-200-13-1016605-0.html>

Другие товары: <https://storgom.ua/glubinnye-nasosy.html>