

# NOVA UP

## SUBMERSIBLE PUMPS



### TECHNICAL DATA

**Operating range:**

from 1 to 15 m<sup>3</sup>/h with head up to 10 metres.

**Liquid temperature range:**

from 0 °C to +35 °C for domestic use.

**Pumped liquid:** dirty water without fibres.

**Minimum draught depth:**

NOVA UP 300 M-A	120 mm
NOVA UP 300 M-NA	60 mm
NOVA UP 600 M-A	165 mm
NOVA UP 600 M-NA	70 mm

**Max. immersion depth:** 7 metres.

**Installation:** vertical, fixed or portable.

**Protection class:** IP 68.

**Insulation class:** F.

### APPLICATIONS

The vertical delivery draining submersible pump is suitable for domestic automatically operated fixed applications, for draining basements and garages that are subject to flooding. Thanks to its compact, easy to handle shape, it may also be used as a portable pump for emergencies such as lifting water from tanks or rivers, emptying swimming pools, fountains, excavations, and pedestrian subways. It is also ideal for gardening, and hobby applications in general. This pump can be used with liquids containing solid particles of up to 10 mm in size. The level switch allows fixed installation, ensuring automatic operation. With removable filter, it is capable of suction of up to a minimum of 2/3 mm (filter removed).

### CONSTRUCTION FEATURES OF THE PUMP

Hydro resistant technopolymer pump body, cover, and suction grid.

Stainless steel motor, roto shaft, and bolts and screws.

Threefold seal with interposed rings with oil pre-chamber.

### CONSTRUCTION FEATURES OF THE MOTOR

Submersible type continuous duty asynchronous motor.

Stator enclosed in airtight stainless steel casing, with an outer cover that protects the wiring and the capacitor. Rotor running on permanently lubricated ball bearings, oversized to ensure low noise and durability. Built-in thermal-ampereometric protection and permanently connected capacitor.

### MATERIALS

N.	PARTS*		MATERIALS
1	SUCTION STRAINER		TECHNOPOLYMER
2	BASE		TECHNOPOLYMER
3	IMPELLER		TECHNOPOLYMER
4	NUT		A2 DIN982-UNI7473 STAINLESS STEEL
5	WASHER		A2 STAINLESS STEEL
6	V. RING		NBR
7	MOTOR	CASE	AISI 304 STAINLESS STEEL X5 CrNi 1810 - UNI 6900/71
		ROTOR SHAFT	AISI 416 STAINLESS STEEL UNI EN 10088-1 X12CRS13
8	DIAPHRAGM		TECHNOPOLYMER
9	BODY		TECHNOPOLYMER
10	OR RING		NBR

\* In contact with the liquid

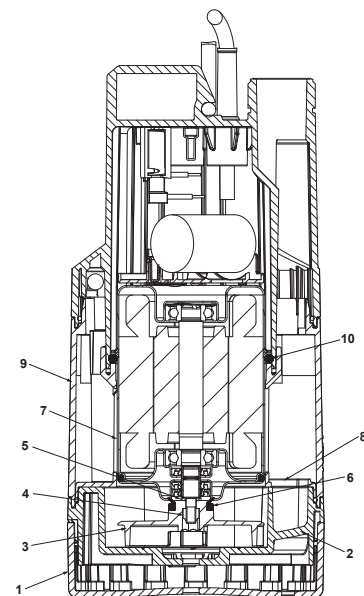

# NOVA RANGE

## SUBMERSIBLE PUMPS

### PERFORMANCE RANGE

The performance curves are based on kinematic viscosity values = 1 mm<sup>2</sup>/s and density equal to 1000 kg/m<sup>3</sup>. Curve tolerance according to ISO 9906.

### GRAPHIC SELECTION TABLE

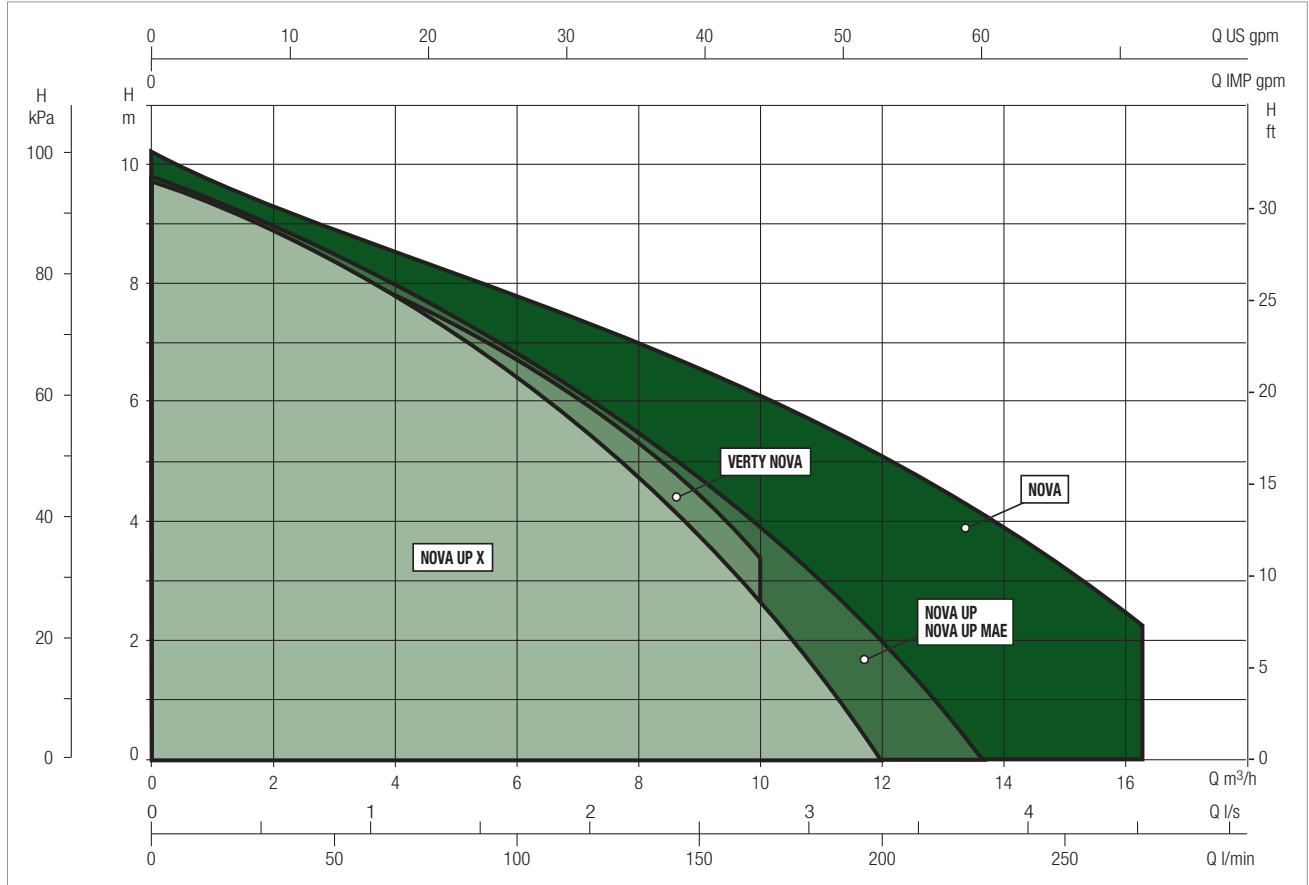

### SELECTION TABLE - NOVA UP

MODEL	Q= m <sup>3</sup> /h	0	1	2	3	4.5	5	6	7	7.5	9	10	12	13.5	15
	Q=l/min	0	16.6	33.3	50	75	83.3	100	116.6	125	150	166.6	200	225	250
NOVA UP 300 M	H	7.6	6.9	6.25	5.6	4.7	4.4	3.6	2.8	2.3	1				
NOVA UP 600 M	H (m)	9.8	9.4	9	8.5	7.7	7.4	6.8	6.2	5.9	4.7	3.9	2	0.3	

# NOVA UP - CLEAN WATER DRAINING SUBMERSIBLE PUMPS FOR DOMESTIC USE

Liquid temperature range: from 0 °C to +35 °C for domestic use

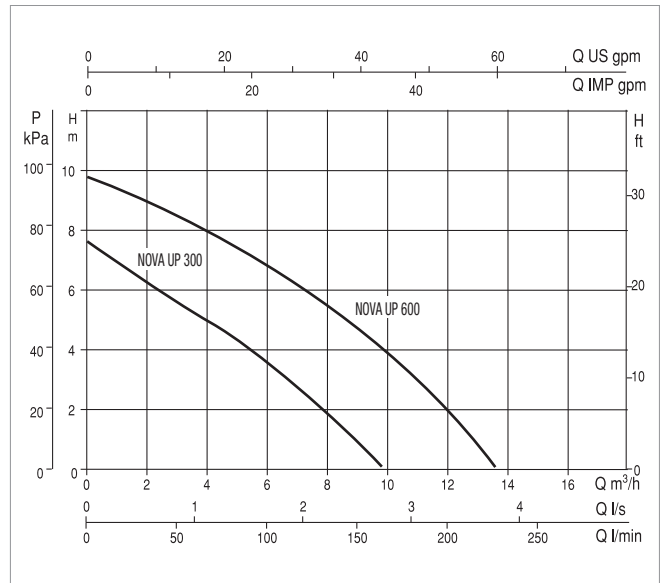
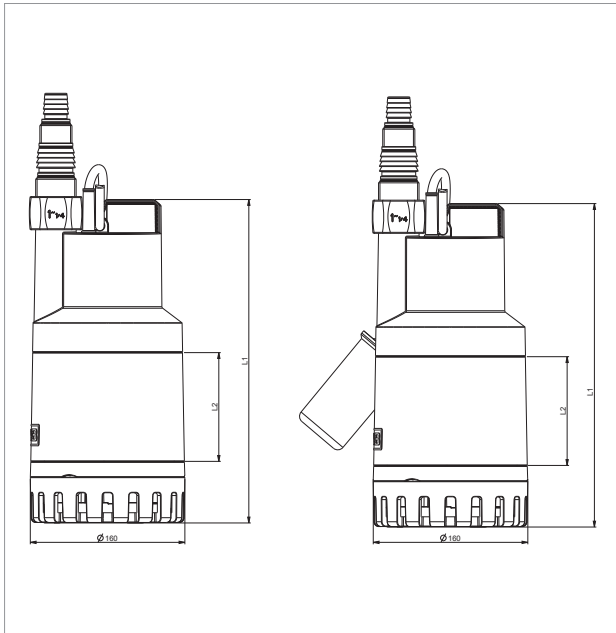

The performance curves are based on kinematic viscosity values = 1 mm<sup>2</sup>/s and density equal to 1000 kg/m<sup>3</sup>. Curve tolerance according to ISO 9906.

MODEL	ELECTRICAL DATA				
	POWER INPUT 50 Hz	P1 MAX kW	P2 NOMINAL		In A
			kW	HP	
NOVA UP 300 M-A	1 x 220 - 240V ~	0.38	0.21	0.28	1.5
NOVA UP 300 M-NA	1 x 220 - 240V ~	0.38	0.21	0.28	1.5
NOVA UP 600 M-A	1 x 220 - 240V ~	0.77	0.52	0.69	3.5
NOVA UP 600 M-NA	1 x 220 - 240V ~	0.77	0.52	0.69	3.5

MODEL	L1	L2	DNM GAS	PACKING DIMENSIONS			CABLE	VOLUME (m <sup>3</sup> )	WEIGHT kg
				L/A	L/B	H			
NOVA UP 300 M-A	296	75.9	1" <sup>3/4</sup>	265	225	317	10 mt.	0.018	5.8
NOVA UP 300 M-NA	296	111.6	1" <sup>3/4</sup>	265	225	317	10 mt.	0.018	5.6
NOVA UP 600 M-A	332	111.6	1" <sup>3/4</sup>	265	225	352	10 mt.	0.021	7.3
NOVA UP 600 M-NA	332	75.9	1" <sup>3/4</sup>	265	225	352	10 mt.	0.021	7.1

## **ОФИЦИАЛЬНЫЙ ДИЛЕР В УКРАИНЕ:**

[storgom.ua](http://storgom.ua)

## **ГРАФИК РАБОТЫ:**

Пн. – Пт.: с 8:30 по 18:30

Сб.: с 09:00 по 16:00

Вс.: с 10:00 по 16:00

## **КОНТАКТЫ:**

+38 (044) 360-46-77

+38 (066) 77-395-77

+38 (097) 77-236-77

+38 (093) 360-46-77

Детальное описание товара:

<https://storgom.ua/product/drenazhnyi-nasos-dab-nova-up-6-0mna-601523-0.html>

Другие товары: <https://storgom.ua/drenazhnye-nasosy.html>