

TOOL CABINETS & CHESTS ACCESSORIES & SETS



ORIGINAL SERIES

A03-5

5 Drawers Mobile Cabinet

- Drawer loading capacity up to 40kg.
- : 50.4kg

	Length mm	Width mm	Height mm	QTY
CABINET	687	459	705	
DRAWER	580	375	75	3
	580	375	154	2



A03-7

7 Drawers Mobile Cabinet

- Drawer loading capacity up to 40kg.
- : 64.5 kg

	Length mm	Width mm	Height mm	QTY
CABINET	687	459	860	
DRAWER	580	375	75	5
	580	375	154	2

BODY

- Curve shaped corner to prevent injury.
- Double-decker enforced construction to increase toughness of the rigid frame.
- Non-Slip top mat for worktop protection.

DRAWER

- Interlock secure system.
- Firm front handle.
- Full-extension drawer with EVA mat base protection.
- Drawer loading capacity up to 40kg.

WHEEL

- Two fixed, and two swivel wheels with anti-rotation brake.
- Max. static loading capacity : 550kg



High strength ball bearing slides: for extended service life.



5x2" PP high-performance roller bearing casters.



EVOLUTION SERIES

BODY

- Curve shaped corner to prevent from injury.
- Double-decker enforced construction to increase toughness of the rigid frame.
- Non-Slip top mat for worktop protection.
- Perforated side panels for tool hangers and hooks.

DRAWER

- Rear-locking interlock mechanism allows only one drawer opened at one time and keeps the other drawers closed for safety purpose. (anti-tilt)
- Auto return function to ensure the drawer is positioned when sliding back.
- Firm front handle.
- Full-extension drawer with EVA mat base protection.
- High strength ball bearing slides, for extended service life.
- Drawer loading capacity up to 40KG.

WHEEL

- TPR high-performance roller bearing casters to reduce noise and absorb vibration.
- Two fixed, and two swivel wheels with anti-rotation brake.
- Max. static loading capacity : 700KG



A04-7

7 Drawers Mobile Cabinet

- Drawer loading capacity up to 40kg.
- 🚚: 64.5 kg

	Length mm	Width mm	Height mm	QTY
CABINET	687	459	860	
DRAWER	580	375	75	5
	580	375	154	2



A04-7B

7 Drawers Mobile Cabinet (Sandy Finished)

- Drawer loading capacity up to 40kg.
- 🚚: 64.5kg

	Length mm	Width mm	Height mm	QTY
CABINET	687	459	860	
DRAWER	580	375	75	5
	580	375	154	2



5x2" Oil resistant TPR high-performance roller bearing casters

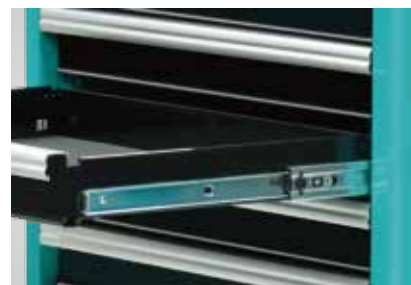

- One drawer opens at one time
- Auto-return slides



Perforated side panels



A04-8

8 Drawers Mobile Cabinet

- Drawer loading capacity up to 40kg
- 🚚: 67.5kg

	Length mm	Width mm	Height mm	QTY
CABINET	687	459	860	
DRAWER	580	375	75	7
	580	375	154	1





Four Swivel Wheels

A05-5

5 Drawers Mobile Cabinet

- Maximum Static Loading Capacity: 210kg
 - Compact size can be stored under Work Bench.
 - Four swivel wheels, two with brake.
 - Drawer loading capacity up to 30kg.
- 📦: 31.3kg



	Length mm	Width mm	Height mm	QTY
CABINET	570	340	769	
DRAWER	479	293	75	3
	479	293	154	2

A31-4

4 Drawers Middle Chest

High strength ball bearing slide drawers with interlock, 100% full-extension.

📦: 33.2kg

	Length mm	Width mm	Height mm	QTY
CABINET	687	459	436	
DRAWER	580	375	75	4

A32-3

3 Drawers Middle Chest

High strength ball bearing slide drawers with interlock, 100% full-extension.

- One drawer opens at one time
- Auto-return slides

📦: 28.3kg

	Length mm	Width mm	Height mm	QTY
CABINET	687	459	360	
DRAWER	580	375	75	3

A32-3B

3 Drawers Middle Chest (Sandy Finished)

High strength ball bearing slide drawers with interlock, 100% full-extension.

- One drawer opens at one time
- Auto-return slides

📦: 28.3kg

	Length mm	Width mm	Height mm	QTY
CABINET	687	459	360	
DRAWER	580	375	75	3



A10-0

Heavy Duty Work Bench

- 12mm beat resistance Pvc board
 - Maximum Static Loading Capacity: 1000kg
 - Sturdy construction for heavy duty applications
- Table - 📦: 52kg, Leg - 📦: 19.5kg

	Length mm	Width mm	Height mm
OVERALL	1565	766	800

A11-3

Back Panel Work Bench

- 12mm beat resistance Pvc board
 - Maximum Static Loading Capacity: 1000kg
 - Sturdy construction for heavy duty applications
 - Perforated wall panel convenient for hooking accessories and tools
- Table - 📦: 52kg, Leg - 📦: 19.5kg
Back Panel - 📦: 13.6kg
3 Drawers Middle Chest - 📦: 28.3kg

	Length mm	Width mm	Height mm	QTY
OVERALL	1565	766	800	
BACK PANEL	1563	671.5		
CABINET	687	459	360	
DRAWER	580	375	75	3



A12-3

Wall Cabinet Work Bench

- 12mm beat resistance Pvc board
 - Maximum Static Loading Capacity: 1000kg
 - Sturdy construction for heavy duty applications
 - Installation compatible with 26" trolley top tool cupboard with lockable rollering
 - Perforated wall panel convenient for hook accessories and tools
- Table - 📦: 52kg, Leg - 📦: 19.5kg
Wall Cabinet - 📦: 35.5kg
3 Drawers Middle Chest - 📦: 28.3kg

	Length mm	Width mm	Height mm	QTY
OVERALL	1565	766	800	
WALL CABINET	1565	203	600	
CABINET	687	459	360	
DRAWER	580	375	75	3



Original Series



Evolution Series



Evolution Series



A90-01

Can Holder

- Easily attached on trolley
- Loading capacity :10kg
- 📦 : 1.25kg

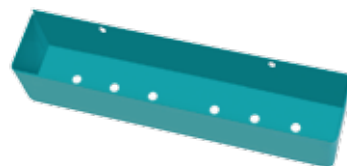

	Length mm	Width mm	Height mm
OVERALL	430	90	102

A90-02

T-Handle Holder

- Easily attached on trolley
- Loading capacity :10kg
- 📦 : 0.58kg



	Length mm	Width mm	Height mm
OVERALL	330	99	60

A90-03

Paper Holder

- Easily attached on trolley
- Loading capacity :10kg
- 📦 : 1.06kg

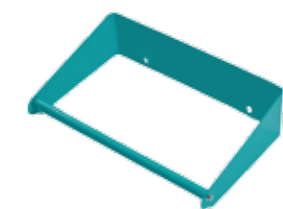

	Length mm	Width mm	Height mm
OVERALL	374	220	100

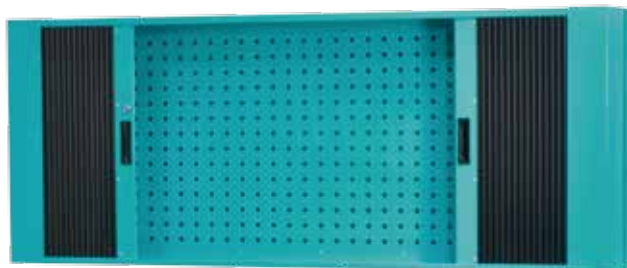
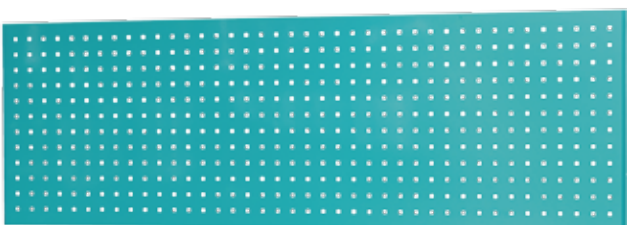

A90-04

Side Foldable Table

- Easily attached on trolley
- Loading capacity :30kg
- 📦 : 4.17kg



	Length mm	Width mm	Height mm
OVERALL	434	415	178

A90-05

Hook

- 📦 : 0.04kg



	Ø mm	Length mm
OVERALL	4.8	50

A90-06

Back Panel (for Cabinet)

- Easily attached on trolley
- Loading capacity :30kg
- 📦 : 3.86kg

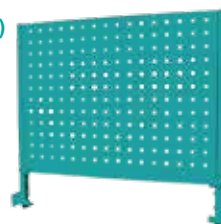

	Length mm	Width mm	Height mm
OVERALL	671	20	536

A91-01

Back Panel (for Work Bench)

- Perforated wall panel convenient for hooking accessories and tools
- 📦 : 13.6kg

	Length mm	Width mm
OVERALL	1563	671.5

A91-02

Wall Cabinet

- Installation compatible with 26" trolley top tool cupboard with lockable rolling
- Perforated wall panel convenient for hook accessories and tools
- 📦 : 35.5kg

	Length mm	Width mm	Height mm
OVERALL	1565	203	600



A03-5089S

A04-7089S

A04-8089S



A03-7089S



A04-7B089S

3-Drawer Tool Trolley, 89pcs

1-Drawer



AN-SD03

AN-TH01

3-Drawer



AN-PL01

AN-PL02

AN-PL04

AN-SD07

2-Drawer

AN-SK07S



AN-WR02

AN-WR01





A03-5162S



A04-7162S



A04-8162S



A03-5375S



A04-7375S



A04-8375S



A03-7162S



A04-7B162S



A03-7375S



A04-7B375S

3-Drawer Tool Trolley, 162pcs

1-Drawer



AN-SD01 AN-PL01 AN-PL04 AN-SK52

3-Drawer



AN-WR01 AN-WR02 AN-HF04

3-Drawer Tool Trolley, 375pcs

1-Drawer



AN-WR03 AN-WR02 AN-SK01S AN-SK13S

3-Drawer



AN-SD07 AN-SD04 AN-HF04

2-Drawer



AN-SK01S AN-SK03S AN-SK06 AN-SK09S



2-Drawer



AN-PL01 AN-PL02 AN-PL04 AN-PL05





A03-5178S

A04-7178S

A04-8178S



A03-5211S

A04-7211S

A04-8211S



A03-7178S

A04-7B178S

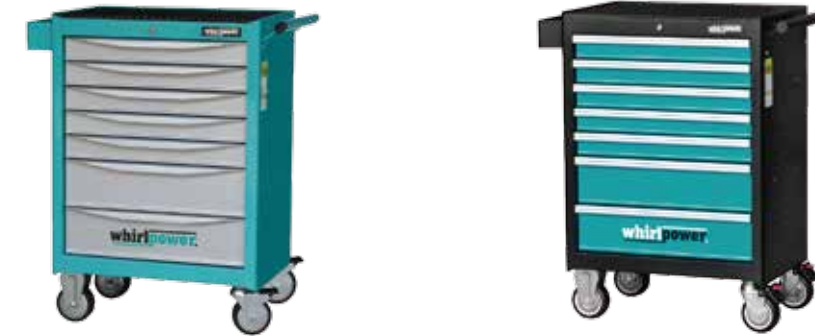

A03-7211S

A04-7B211S

4-Drawer Tool Trolley, 178pcs

1-Drawer



AN-SK01S AN-SK03S AN-SK06 AN-SK09S

3-Drawer



AN-WR02 AN-WR03 AN-WR05 AN-WR08

2-Drawer



AN-SD06 AN-PL01 AN-PL04

4-Drawer



AN-SD02 AN-HF05

4-Drawer Tool Trolley, 211pcs

1-Drawer



AN-PL01 AN-PL02 AN-SD03

3-Drawer



AN-SD07 AN-WR02 AN-WR03 AN-SK04S

2-Drawer



AN-PL04 AN-HF04

4-Drawer



AN-SK01S AN-SK08S





A03-5224S



A04-7224S



A04-8224S



A03-7224S



A04-7B224S



A03-7205S



A04-7205S



A04-7B205S



A04-8205S

2-Drawer



AN-WR02 AN-SK01S AN-SK03S AN-SK52

3-Drawer



AN-PL01 AN-SK08S AN-SD04

4-Drawer



AN-PL02 AN-TK02 AN-HF04

4-Drawer Tool Trolley, 224pcs

1-Drawer



AN-WR02 AN-WR03 AN-WR05 AN-PL01

3-Drawer



AN-SK07S AN-SK52 AN-HF05

2-Drawer



AN-SK01S AN-SK03S AN-SK10 AN-PL04

4-Drawer



AN-SD06 AN-TK05

5-Drawer Tool Trolley, 205pcs

1-Drawer



AN-WR03 AN-WR07

5-Drawer



AN-TH01 AN-TK05





A03-7272S

A04-7272S



A04-7B272S

A04-8272S

7-Drawer Tool Trolley, 272pcs

1-Drawer



AN-WR02

AN-WR05

AN-WR08

AN-SK52

2-Drawer



AN-PL01

AN-WR01

AN-WR04

3-Drawer

AN-SK07S

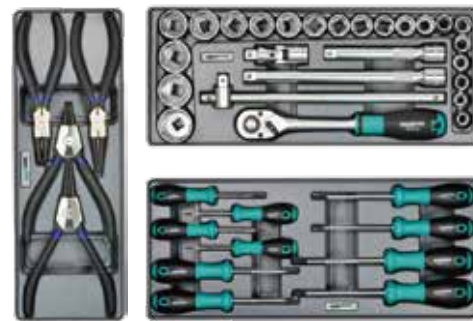

AN-PL02

AN-SD02

4-Drawer

AN-HF04



AN-PL04

AN-HF01

5-Drawer



AN-SD03

AN-SK01S

AN-SK04S

6-Drawer



AN-TH01

AN-TH04

7-Drawer



AN-TK01

AN-TK03

AN-TK05

AN-SD01

Screwdriver Set, 8pcs



(L) 363 x (W) 130 x (H) 48mm



Series	Contents	Weight
3 S111-4	⊖ 5.5x125, 6.5x150, 8.0x175	0.75kg
3 S111-6	⊖ 3.0x75, 3.5x100, 4.0x100	
2 S112-4	⊕ 1x80, 2x100	

AN-SD02

Torks Screwdriver Set, 10pcs



(L) 420 x (W) 179 x (H) 48mm



Series	Contents	Weight
10 S114	⊖ 6, 7, 8, 9, 10, 15, 20, 25, 27, 30	0.65kg

AN-SD03

Go-Thru Screwdriver Set, 12pcs



(L) 363 x (W) 270 x (H) 48mm



Series	Contents	Weight
6 S111-5	⊖ 5.5x125, 6.5x150, 8.0x175, 10.0x200, 12.0x200, 14.0x250	2.42kg
4 S112-5	⊕ 1x80, 2x100, 3x150, 4x200	
1 1711-7	⊖ 5.5x25	
1 1712-6	⊕ 2x25	

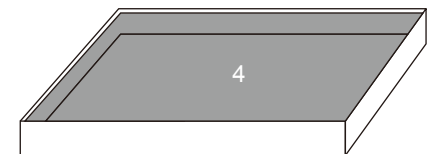
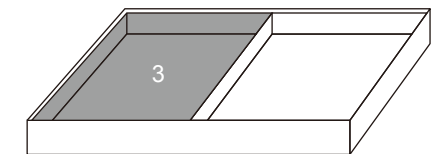
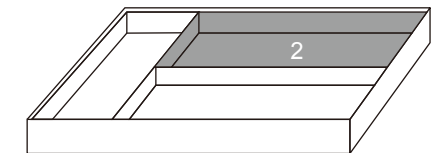
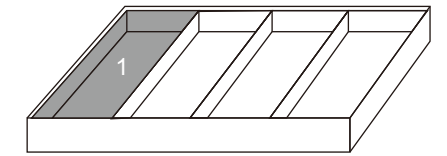

All Whirlpower tools sets for cabinets are provided in user-friendly modular units. Each drawer consists of multiple plastic trays, sizes of 1/2, 3/8 and 1/4 full drawer size.

Users are able to make their own combination exchange between different drawers and different cabinets.

AN-SD04

Screwdriver Set, 10pcs

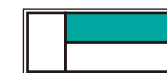

(L) 420 x (W) 179 x (H) 48mm



Series	Contents	Weight
3 S111-4	⊖ 5.5x125, 6.5x150, 8.0x175	1.0kg
3 S111-6	⊖ 3.0x75, 3.5x100, 4.0x100	
1 S112-3	⊕ 0x60	
3 S112-4	⊕ 1x80, 2x100, 3x150	



AN-SD05

Nutspinner Set, 6pcs



(L) 363 x (W) 130 x (H) 48mm

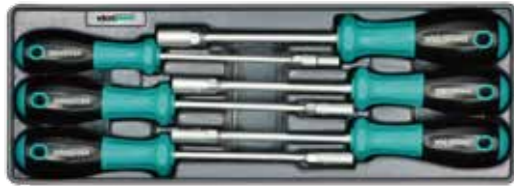

Series	Contents	Weight
6 S117-1	⊖ 5.5, 6, 7, 8, 9, 10mm	0.72kg

AN-SD06

Screwdriver Set, 13pcs



(L) 363 x (W) 270 x (H) 48mm



Series	Contents	Weight
2 S111-3	⊖ 6.5x150, 8.0x175	1.1kg
4 S111-6	⊖ 2.5x75, 3.0x75, 3.5x100, 4.0x100	
3 S112-3	⊕ 1x80, 2x100, 3x150	
2 S113-3	⊕ 1x80, 2x100	
1 1711-7	⊖ 5.5x25	
1 1712-6	⊕ 2x25	

AN-SD07

Files Set, 5pcs



(L) 363 x (W) 130 x (H) 48mm



Series	Contents	Weight
5 15407-1	File, 200mm	0.74kg
15407-1	Flat	
15407-2	Half-Round	
15407-3	Round	
15407-4	Triangle	
15407-5	Square	

AN-SD08

Insulated Screwdriver Set, 10pcs



(L) 420 x (W) 179 x (H) 48mm



Series	Contents	Weight
7 V111	⊖ 2.5x75, 3.0x100, 3.5x100, 4.0x100	0.83kg
	5.5x125, 6.5x150, 8.0x175	
3 V112	⊕ 0x60, 1x80, 2x100	

AN-SD09

Insulated Tool Set, 11pcs



(L) 420 x (W) 179 x (H) 48mm



Series	Contents	Weight
4 V111	⊖ 3.0x100, 4.0x100, 5.5x125, 6.5x150	1.43kg
3 V112	⊕ 0x60, 1x80, 2x100	
1 15701-321	Insulated Combination Pliers, 180mm	
1 15702-311	Insulated Long Nose Pliers, 200mm	
1 15704-21	Insulated Heavy Duty Diagonal Cutting Nippers, 180mm	
1 M051-01	Voltage Tester, 120-250V	

AN-SD10

Insulated Tool Set, 11pcs



(L) 420 x (W) 179 x (H) 48mm



Series	Contents	Weight
4 V111	⊖ 3.0x100, 4.0x100, 5.5x125, 6.5x150	1.32kg
3 V112	⊕ 0x60, 1x80, 2x100	
1 15702-311	Insulated Long Nose Pliers, 200mm	
1 15704-12	Insulated Diagonal Cutting Pliers, 160mm	
1 15706	Insulated Wire Strippers, 180mm	
1 M051-01	Voltage Tester, 120-250V	

AN-PL01

Pliers Set, 4pcs



(L) 363 x (W) 130 x (H) 48mm



Series	Contents	Weight
1 15601-321	Combination Pliers, 180mm	1.2kg
1 15602-211	Long Nose Pliers, 200mm	
1 15603-211	Bent Nose Pliers, 200mm	
1 15604-21	Heavy Duty Diagonal Cutting Nippers, 180mm	

AN-PL02

Circlip Pliers Set, 4pcs



(L) 363 x (W) 130 x (H) 48mm



Series	Contents	Weight
4 15618-01	External Straight Nose, 180mm	0.7kg
15618-02	External Bent Nose, 185mm	
15618-03	Internal Straight Nose, 170mm	
15618-04	Internal Bent Nose, 170mm	

AN-PL03

Terminal Tool Set, 4pcs



(L) 420 x (W) 179 x (H) 48mm



Series	Contents	Weight
3 1771-1	Crimping Pliers, 230mm	1.92kg
1772-3	0.1-1.0mm ² , Awg28-18	
1772-4	0.5-6mm ² , Awg20-10	
1 17713-1	Self-Adjusting Cutter Stripper, 170mm	

AN-PL04

Tool Set, 3pcs



(L) 363 x (W) 130 x (H) 48mm



Series	Contents	Weight
1 1249-3	Adjustable Wrench, 250mm	1.38kg
1 15608-02	Water Pump Pliers, 250mm	
1 16421-1	Curved Jaw Locking Pliers, 224mm	

AN-PL05

Hand Riveter Set, 251pcs



(L) 363 x (W) 130 x (H) 48mm



Series	Contents	Weight
1 166-1	Hand Riveter, 260mm	0.93kg
250	Blind Rivet	
	2.4 × 5.8mm x 50pcs	
	3.2 × 6.4mm x 50pcs	
	3.2 × 8mm x 50pcs	
	4.0 × 8mm x 50pcs	
	4.8 × 8mm x 50pcs	

AN-PL06

Industrial Lever Riveter Set, 251pcs



(L) 420 x (W) 179 x (H) 48mm



Series	Contents	Weight
1 166-9	Lever Riveter With Soft Grip, 285mm	1.2kg
250	Blind Rivet	
	2.4 × 5.8mm x 50pcs	
	3.2 × 6.4mm x 50pcs	
	3.2 × 8mm x 50pcs	
	4.0 × 8mm x 50pcs	
	4.8 × 8mm x 50pcs	



AN-WR01

Double Open End Wrenches Set, 11pcs



(L) 420 x (W) 179 x (H) 48mm



Series	Contents	Weight
11 1241-1	6x7, 8x9, 10x11, 12x13, 14x15, 16x17, 18x19, 20x22, 21x23, 24x27, 30x32mm	1.95kg

AN-WR02

Combination Wrenches 15° Offset Ring Set, 16pcs



(L) 363 x (W) 130 x (H) 48mm



Series	Contents	Weight
16 1242-1	6, 7, 8, 9, 10, 11, 12, 13, 14, 15, 16, 17, 18, 19, 22, 24mm	1.6kg

AN-WR03

Double Ring Deep 75° Offset Wrenches Set, 8pcs



(L) 363 x (W) 130 x (H) 48mm



Series	Contents	Weight
8 1243-1	6x7, 8x9, 10x11, 12x13, 14x15, 16x17, 18x19, 20x22mm	1.45kg

AN-WR04

Double Ended Angled Socket Wrenches Set, 11pcs



(L) 420 x (W) 179 x (H) 48mm



Series	Contents	Weight
11 1244-42	8, 10, 11, 12, 13, 14, 15, 16, 17, 18, 19mm	2.54kg

AN-WR05

Double Hinged Socket Wrenches Set, 7pcs



(L) 363 x (W) 130 x (H) 48mm



Series	Contents	Weight
7 1244-43	8x9, 10x11, 12x13, 14x15, 16x17, 18x19, 20x22mm	1.97kg

AN-WR06

Double Ring Deep 75° Offset Wrenches Set, 4pcs



(L) 420 x (W) 179 x (H) 48mm



Series	Contents	Weight
4 1243-1	21x23, 24x26, 25x28, 30x32mm	2.34kg

AN-WR07

Combination Wrenches 15° Offset Ring Set, 4pcs



(L) 420 x (W) 179 x (H) 48mm



Series	Contents	Weight
4 1242-1	27, 29, 30, 32mm	1.94kg

AN-WR08

Flare Nut Wrenches Set, 6pcs



(L) 363 x (W) 130 x (H) 48mm



Series	Contents	Weight
6 1245-51	8x10, 10x12, 11x13, 12x14, 17x19, 19x22mm	0.88kg

AN-WR09

High Torque Ratchet Wrenches Set, 16pcs



(L) 363 x (W) 130 x (H) 48mm



Series	Contents	Weight
12 1244-11	High Torque Ratchet Wrenches 8, 9, 10, 11, 12, 13, 14, 15, 16, 17, 18, 19mm	1.46kg
3	Ratchet Driver Head 1/4", 3/8", 1/2"	
1	Hex Ratchet Bitholder 1/4"	

Insert ratchet driver head into the box end, it can be used with socket and bit

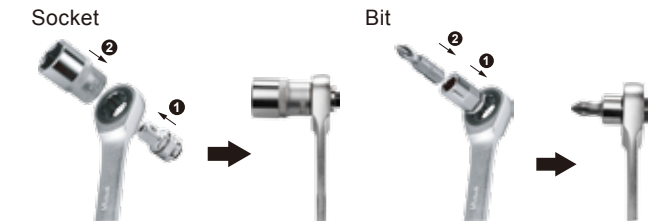

AN-SK01S

Socket and Tool Set, 43pcs 1/4"



(L) 363 x (W) 130 x (H) 48mm



Series	Contents	Weight
12 16121-11	1/4" Sockets, 6-Point 4, 5, 5.5, 6, 7, 8, 9, 10, 11, 12, 13, 14mm	1.2kg
12 16121-12	1/4" Deep Sockets, 6-Point 4, 5, 5.5, 6, 7, 8, 9, 10, 11, 12, 13, 14mm	
1 16122-04	1/4" Ratchet Handle, 36T	
1 16123-02	1/4" Extension Bars, 55mm	
1 16124-01	1/4" Sliding T Bar, 115mm	
1 16124-04	1/4" Spinner Handle, 145mm	
1 16125-01	1/4" Universal Joint, 40mm	
1 16125-04	3/8" x 1/4" Adapter	
12	1/4" Bit Sockets, 32mm	
16127-11	⊖ 3.5, 5.5, 8.0	
16127-21	⊕ 1, 2	
16127-31	⊕ 1, 2	
16127-61	● 3, 4, 5, 6, 8	
1 1739-21	1/4" Speed Extension Bar, 150mm	



AN-SK02

Torque Wrenches and Ratchet Set, 4pcs $\frac{1}{4}$ "



(L) 363 x (W) 130 x (H) 48mm



Series	Contents	Weight
1 16122-04	1/4" Ratchet Handle, 36T	0.82kg
1 16122-07	1/4" Swivel Ratchet Handle, 72T	
1 16122-08	1/4" Stubby Ratchet Handle, 36T	
1 168-6	1/4" Torque Wrench(6-30NM), 222mm	

AN-SK03S

Socket Set, 24pcs $\frac{3}{8}$ "



(L) 363 x (W) 130 x (H) 48mm



Series	Contents	Weight
17 16131-11	3/8" Sockets, 6-Point 6, 7, 8, 9, 10, 11, 12, 13, 14, 15 16, 17, 18, 19, 20, 21, 22mm	1.72kg
1 16132-02	3/8" Ratchet Handle, 36T	
2 16133-02	3/8" Extension Bars, 75, 150mm	
1 16134-01	3/8" Sliding T Bar, 165mm	
1 16135-01	3/8" Universal Joint, 55mm	
2 16138-1	3/8" Spark Plug Sockets, 16, 21mm	

AN-SK04S

Socket Set, 26pcs $\frac{3}{8}$ "



(L) 363 x (W) 130 x (H) 48mm



Series	Contents	Weight
16 16131-11	3/8" Sockets, 6-Point 6, 7, 8, 9, 10, 11, 12, 13, 14, 15 16, 17, 18, 19, 21, 22mm	1.77kg
1 16132-02	3/8" Ratchet Handle, 36T	
2 16133-02	3/8" Extension Bars, 150, 230mm	
1 16134-01	3/8" Sliding T Bar, 200mm	
1 16135-01	3/8" Universal Joint, 55mm	
5 16137-61	3/8" Bit Sockets, 48mm 4, 5, 6, 8, 10	

AN-SK05

Torque Wrenches and Ratchet Set, 7pcs $\frac{3}{8}$ "



(L) 420 x (W) 179 x (H) 48mm



Series	Contents	Weight
3 12733-5	3/8" Magnetic Spark Plug Sockets, 16, 18, 21mm	2.34kg
1 16132-02	3/8" Ratchet Handle, 36T	
1 16132-06	3/8" Swivel Ratchet Handle, 72T	
1 16132-07	3/8" Stubby Ratchet Handle, 36T	
1 168-6	3/8" Torque Wrenches(20-110NM), 410mm	

AN-SK06

Accessory Set, 6pcs $\frac{1}{2}$ "



(L) 363 x (W) 130 x (H) 48mm



Series	Contents	Weight
1 16142-02	1/2" Ratchet Handle, 36T	2.0kg
3 16143-02	1/2" Extension Bars, 50, 125, 250mm	
1 16144-01	1/2" Sliding T Bar, 250mm	
1 16145-02	1/2" Universal Joint, 78mm	

AN-SK07S

Socket Set, 26pcs $\frac{1}{2}$ "



(L) 420 x (W) 179 x (H) 48mm



Series	Contents	Weight
21 16141-11	1/2" Sockets, 6-Point 10, 11, 12, 13, 14, 15, 16, 17, 18, 19, 20 21, 22, 23, 24, 26, 27, 28, 30, 32, 34mm	4.2kg
1 16142-02	1/2" Ratchet Handle, 36T	
2 16143-02	1/2" Extension Bars, 150, 250mm	
1 16144-01	1/2" Sliding T Bar, 300mm	
1 16145-02	1/2" Universal Joint, 78mm	

AN-SK08S

Socket Set, 32pcs $\frac{1}{2}$ "



(L) 420 x (W) 179 x (H) 48mm



Series	Contents	Weight
20 16141-11	1/2" Sockets, 6-Point 10, 11, 12, 13, 14, 15, 16, 17, 18, 19, 20 21, 22, 23, 24, 26, 27, 28, 30, 32mm	4.3kg
1 16142-02	1/2" Ratchet Handle, 36T	
2 16143-02	1/2" Extension Bars, 150, 250mm	
1 16145-02	1/2" Universal Joint, 78mm	
1 16145-04	3/8" x 1/2" 3-Way Adapter	
5 16147-61	1/2" Bit Sockets, 55mm 4, 5, 6, 8, 10	
2 16148-1	1/2" Spark Plug Sockets, 16, 21mm	

AN-SK09S

Socket Set, 22pcs $\frac{1}{2}$ "



(L) 363 x (W) 130 x (H) 48mm



Series	Contents	Weight
22 16141-11	8, 10, 11, 12, 13, 14, 15, 16, 17, 18, 19, 20, 21 22, 23, 24, 26, 27, 28, 30, 32, 34mm	2.3kg

AN-SK12S

Socket Sets, 14pcs $\frac{1}{2}$ "



(L) 363 x (W) 130 x (H) 48mm



Series	Contents	Weight
11 16141-11	1/2" Sockets, 6-Point 10, 11, 12, 13, 14, 15, 17, 19, 21, 22, 24mm	2kg
1 16142-02	1/2" Ratchet Handle, 36T	
1 16143-02	1/2" Extension Bar, 125mm	
1 16144-01	1/2" Sliding T Bar, 300mm	

AN-SK10

Torks Socket, Wrench and Bit Set, 49pcs $\frac{1}{4}$ " $\frac{3}{8}$ " $\frac{1}{2}$ "



(L) 363 x (W) 130 x (H) 48mm



Series	Contents	Weight
11 964-11	1/4" Bits, 25mm 6, 7, 8, 9, 10, 15, 20, 25, 27, 30, 40	1.6kg
1 964-22	1/4" Bits, 70mm 25	
1 969-2-11	1/4" Adapter, 25mm	
4 1243-5	Double Ring Torks Wrenches 6x8, 10x12, 14x18, 20x24mm	
11 1584-3	Short Torks Key Wrenches 6, 7, 8, 9, 10, 15, 20, 25, 27, 30, 40	
5 16121-31	1/4" Torks Sockets, E4, E5, E6, E7, E8	
1 16122-14	1/4" Hex Ratchet Handle, 36T	
1 16125-06	Coupler, 1/4"x1/4"	
4 16131-31	3/8" Torks Sockets, E10, E11, E12, E14	
1 16135-06	Coupler, 5/16"x3/8"	
2 16137-41	3/8" Bits Sockets, 48mm 40, 45	
4 16141-31	1/2" Torks Sockets, E16, E18, E20, E24	
3 16147-41	1/2" Bit Sockets, 55mm 50, 55, 60	

AN-SK11S

Torque Wrenches and Socket Set, 8pcs $\frac{1}{2}$ "



(L) 570 x (W) 370 x (H) 48 mm



Series	Contents	Weight
3 12742-62	1/2" Impact Deep Sockets, 6-Point 17, 19, 21mm	3.99kg
1 1249-4	4-Way Lug Wrench Sockets 17, 19, 21mm, 1/2"	
3 16141-11	1/2" Sockets, 6-Point 17, 19, 21mm	
1 168-6	1/2" Torque Wrenches(40-210NM), 505mm	



AN-SK13S

Socket Sets, 19pcs $\frac{1}{2}$ "



(L) 363 x (W) 130 x (H) 48mm



Series	Contents	Weight
14 16141-11	1/2" Sockets, 6-Point 10, 11, 12, 13, 14, 15, 17, 19, 21, 22, 24, 27, 30, 32mm	2.2kg
1 16142-02	1/2" Ratchet Handle, 36T	
2 16143-02	1/2" Extension Bars, 125, 250mm	
1 16144-01	1/2" Sliding T Bar, 300mm	
1 16145-02	1/2" Universal Joint, 78mm	

AN-SK51

Bit Socket Set, 13pcs $\frac{1}{2}$ "



(L) 363 x (W) 130 x (H) 48mm



Series	Contents	Weight
9 16147-61	1/2" Bit Sockets, 55mm 5, 6, 7, 8, 10, 12, 14, 17, 19	1.61kg
4 16147-61	1/2" Bit Sockets, 140mm 6, 7, 8, 10	

AN-SK52

Bit Socket Set, 13pcs $\frac{1}{2}$ "



(L) 363 x (W) 130 x (H) 48mm



Series	Contents	Weight
13 16147-41	40x100, 45x100, 55x140, 70x140	1.89kg
16147-61	5x180, 6x100, 7x100, 8x100, 10x140	
16147-81	6x100, 8x100, 10x100, 12x140	

AN-SK53

Bit Socket Set, 25pcs $\frac{1}{2}$ "



(L) 363 x (W) 130 x (H) 48mm



Series	Contents	Weight
25 16147-41	20, 25, 27, 30, 40, 45, 50, 55, 60	2.49kg
16147-61	5, 6, 7, 8, 9, 12, 14, 17, 19	
16147-81	5, 6, 8, 10, 12, 14, 16	

AN-SK54

Socket and Bit Socket Set, 36pcs $\frac{1}{2}$ "



(L) 420 x (W) 179 x (H) 48mm



Series	Contents	Weight
9 16141-31	1/2" Torks Sockets E10, E11, E12, E14, E16, E18, E20, E22, E24	3.56kg
8 16141-32	1/2" Torks Deep Sockets E10, E11, E12, E14, E16, E18, E20, E24	
19 16147-41	1/2" Bit Sockets, 55mm 40, 45, 50, 55, 60, 70	
16147-51	40, 45, 50, 55, 60, 70	
16147-81	5, 6, 8, 10, 12, 14, 16	

AN-SK55

Bit Socket Set, 18pcs $\frac{1}{2}$ "



(L) 420 x (W) 179 x (H) 48mm



Series	Contents	Weight
9 16147-41	1/2" Bit Sockets, 55mm 20, 25, 27, 30, 40, 45, 50, 55, 60	2.28kg
9 16147-41	1/2" Bit Sockets, 140mm 20, 25, 27, 30, 40, 45, 50, 55, 60	

AN-SK56

Bit Socket Set, 18pcs $\frac{1}{2}$ "



(L) 420 x (W) 179 x (H) 48mm



Series	Contents	Weight
9 16147-61	1/2" Bit Sockets, 55mm 5, 6, 7, 8, 9, 12, 14, 17, 19	2.28kg
9 16147-61	1/2" Bit Sockets, 140mm 5, 6, 7, 8, 9, 12, 14, 17, 19	

AN-IS01

Impact Socket Set, 14pcs $\frac{1}{2}$ "



(L) 363 x (W) 130 x (H) 48mm



Series	Contents	Weight
14 12742-62	1/2" Impact Deep Sockets 10, 11, 12, 13, 14, 15, 16, 17, 18, 19, 21, 22, 23, 24mm	2.83kg

AN-IS02

Impact Socket Set, 19pcs $\frac{1}{2}$ "



(L) 363 x (W) 130 x (H) 48mm



Series	Contents	Weight
17 12742-61	1/2" Impact Sockets 10, 11, 12, 13, 14, 15, 16, 17, 18, 19, 21, 22, 23, 24, 27, 30, 32mm	2.57kg
1 12742-81	1/2" Impact Universal Joint, 64mm	
1 12742-91	1/2" Impact Extension Bar, 125 mm	

AN-IS03

Impact Socket Set, 27pcs $\frac{1}{2}$ "



(L) 363 x (W) 130 x (H) 48mm



Series	Contents	Weight
17 12742-61	1/2" Impact Sockets 10, 11, 12, 13, 14, 15, 16, 17, 18, 19, 21, 22, 23, 24, 27, 30, 32mm	2.57kg
1 12742-82	1/2" Impact Universal Joint, 64mm	
1 12742-92	1/2" Impact Extension Bar, 125 mm	
8 12749-01	1/2" O-Ring, Size(8-14)x2, Size(15-32)x2 1/2" Pin, Size(8-14)x2, Size(15-32)x2	

AN-TH01

Hex Screwdriver Set, 8pcs



(L) 363 x (W) 270 x (H) 48mm



Series	Contents	Weight
8 1516-6	2, 2.5, 3, 4, 5, 6, 8, 10	1.01kg

AN-TH02

Torks Screwdriver Set, 8pcs



(L) 363 x (W) 270 x (H) 48mm



Series	Contents	Weight
8 1514-4	15, 20, 25, 27, 30, 40, 45, 50	1.04kg



AN-TH03

Hex Nutspinner Set, 5pcs



Series	Contents	Weight
5 15171	○ 5, 5.5, 6, 7, 8	0.76kg

AN-TH04

Hex Nutspinner Set, 5pcs



Series	Contents	Weight
5 15171	○ 9, 10, 11, 12, 13	1.03kg

AN-HF01

Punches Set, 11pcs



Series	Contents	Weight
6 138-03	Pin Punches, 2, 3, 4, 5, 6, 8mm	1.33kg
4 138-04	Taper Punches, 4, 5, 6, 8mm	
1 138-05	Center Punch, 6mm	

AN-HF02

Hammer File Set, 12pcs



Series	Contents	Weight
2 1382-01	Flat Chisel, 19, 25mm	2.19kg
1 1382-02	Cross Cut Chisel, 5mm	
5 1382-03	Pin Punches, 2, 3, 4, 5, 6mm	
1 1382-04	Taper Punch, 6mm	
1 1382-05	Center Punch, 6mm	
1 1383-82	Ball Peen Hammer, 225g	
1 1384-85	Interchangeable-tip Mallets, 32mm	

AN-HF03

Hammer File Set, 12pcs



Series	Contents	Weight
2 1382-01	Flat Chisel, 19, 25mm	2.33kg
1 1382-02	Cross Cut Chisel, 5mm	
5 1382-03	Pin Punches, 2, 3, 4, 5, 6mm	
1 1382-04	Taper Punch, 6mm	
1 1382-05	Center Punch, 6mm	
1 1383-82	Ball Peen Hammer, 225g	
1 1384-84	Dead-Blow Hammer, 38mm	

AN-HF04

Hammer File Set, 12pcs

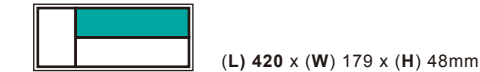

Series	Contents	Weight
2 1382-01	Flat Chisel, 19, 25mm	2.67kg
1 1382-02	Cross Cut Chisel, 5mm	
5 1382-03	Pin Punches, 2, 3, 4, 5, 6mm	
1 1382-04	Taper Punch, 6mm	
1 1382-05	Center Punch, 6mm	
1 1383-81	Engineer's Hammer, 300g	
1 1384-84	Dead-Blow Hammer, 38mm	

AN-HF05

Hammer File Set, 12pcs



Series	Contents	Weight
2 1382-01	Flat Chisel, 19, 25mm	2.53kg
1 1382-02	Cross Cut Chisel, 5mm	
5 1382-03	Pin Punches, 2, 3, 4, 5, 6mm	
1 1382-04	Taper Punch, 6mm	
1 1382-05	Center Punch, 6mm	
1 1383-81	Engineer Hammer, 300g	
1 1384-85	Interchangeable-tip Mallets, 32mm	

AN-HF06

Hammer File Set, 12pcs



Series	Contents	Weight
2 1382-01	Flat Chisel, 19, 25mm	2.53kg
1 1382-02	Cross Cut Chisel, 5mm	
5 1382-03	Pin Punches, 2, 3, 4, 5, 6mm	
1 1382-04	Taper Punch, 6mm	
1 1382-05	Center Punch, 6mm	
1 1383-85	Riveting Hammer, 30mm	
1 1384-84	Dead-Blow Hammer, 38mm	

AN-HF07

Hammer File Set, 12pcs



Series	Contents	Weight
2 1382-01	Flat Chisel, 19, 25mm	2.4kg
1 1382-02	Cross Cut Chisel, 5mm	
5 1382-03	Pin Punches, 2, 3, 4, 5, 6mm	
1 1382-04	Taper Punch, 6mm	
1 1382-05	Center Punch, 6mm	
1 1383-85	Riveting Hammer, 30mm	
1 1384-85	Interchangeable-tip Mallets, 32mm	

AN-TK01

Screw Repair Tools Set, 23pcs 1/2"

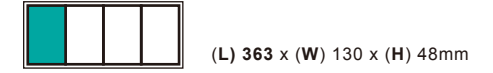

Series	Contents	Weight
1 16136-91	Adapter, 3/8"Dr. x 5/16"Hex	2.39kg
1 16145-05	Coupler, 5/16"x1/2"	
1 F011-01	1/2" Impact Driver	
3 F012-02	Nut Splitter 9-12mm(5/16"-1/2") 12-16mm(1/2"-5/8") 16-22mm(5/8"-7/8")	
4	5/16" Bits, 36mm	
F011-11	⊖ 8.0, 10.0	
F011-21	⊕ 2, 3	
4	5/16" Bits, 80mm	
F011-12	⊖ 8.0, 10.0	
F011-22	⊕ 2, 3	
4 F012-03	Stud Extractor, 6, 8, 10, 12mm	
5 F013-04	Extractor Bits, 1/8", 1/4", 5/16", 7/16", 9/16"	

AN-TK02

Measuring Tools Set, 10pcs

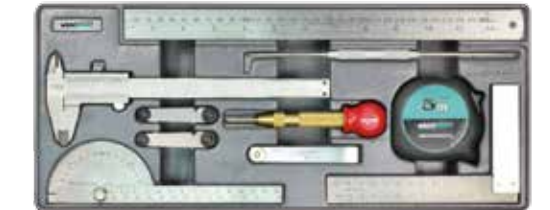
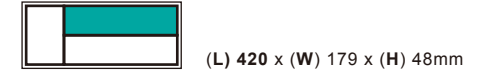

Series	Contents	Weight
1 G011-02	Straight Ruler, 300mm	1.1kg
1 G012-03	Protractor, 150mm	
1 G013-04	Squares(150x100mm)	
1 G015-06	Feeler Gauges, 26 Sizes (SAE 0.002" ~ 0.025" and Metric 0.05-0.63mm)	
1 G016-07	Metric Screw Pitch Gauges (0.25-6mm)	
1 G016-08	SAE Screw Pitch Gauges (4-48)	
1 G017-01	Vernier Caliper, 150mm	
1 G018-09	5M Metric Tape Ruler	
1 G019-10	Auto Center Punch	
1 G019-11	Engineer Scriber	

AN-TK03

Tool Set, 15pcs $3/8"$ $1/2"$



(L) 363 x (W) 130 x (H) 48mm



Series	Contents	Weight
2 12733-5	3/8" Magnetic Spark Plug Sockets, 16, 21mm	1.82kg
1 16131-12	3/8" Deep Socket, 21mm	
2 16133-02	3/8" Extension Bars, 75, 230mm	
1 16145-04	3-Way Adapter, 3/8" $1/2"$	
1 G015-05	20 Sizes Metrie Feeler Gauges(0.05~1.00mm)	
1 U022-01	Oil Filter Strap Wrench	
6 U022-11	Oil Drain Plug Key	
	5/16" \times 3/8"	
	8mm \times 3/8"	
	8mm \times 10mm	
	11mm \times 12mm	
	13mm \times 14mm	
	17mm \times 1/2"	
1 U003-01	Telescope Mirror Stick/Magnetic Pick-Up	

AN-TK04

Tie Tape Pliers Kit Set, 161pcs

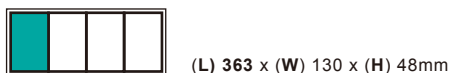

(L) 363 x (W) 130 x (H) 48mm



Series	Contents	Weight
1 F01-09	Cable Tie Gun	0.43kg
160	Cable Tie	
	2.5 x 100mm x 50pcs	
	3.6 x 150mm x 40pcs	
	3.6 x 180mm x 40pcs	
	4.8 x 200mm x 30pcs	

AN-TK06

Tool Set, 9pcs

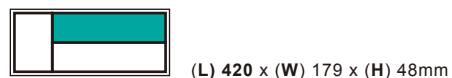

(L) 420 x (W) 179 x (H) 48mm



Series	Contents	Weight
5 138-0305	Chisel Punches Set, 5pcs	1.29kg
1 17107-6	Triangular Scraper, 150mm	
1 G018-09	3M Metric Tape Ruler	
1 G019-11	Engineer Scriber	
1 C021-01	Hacksaw W/12" Blade	

AN-TK05

Cutting Tool Set, 6pcs



(L) 363 x (W) 270 x (H) 48mm



Series	Contents	Weight
1 959-6	1Kg Flexible Claw Pick-Up Tool, 400mm	1.46kg
1 15409-4	Gasket Scraper, 160mm	
1 15619-04	Straight Shears, 265mm	
1 C021-02	Mini Hacksaw W/6" Blade	
1 C022-03	Industrial Safety Utility Knife, 165mm	
1 C023-04	Scissor, 140mm	

Whirlpower's Tool Set in plastic tray (1/4 full drawer size) can fit in a steel Box and also color carton Box as well.



A



Drawer

B

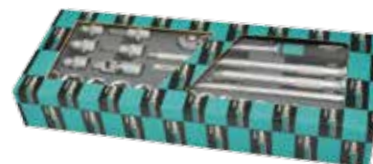

Color Carton Box

C



Steel Box



A03-5117S

A04-7117S

A04-8117S

A03-7117S

A04-7B117S

4-Drawer EVA Tool Trolley, 117pcs

1-Drawer

3-Drawer



AE-SD01

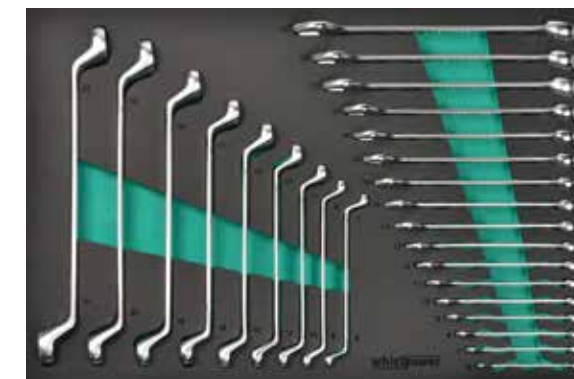

AE-WR01

2-Drawer

4-Drawer



AE-SK01S



AE-TK01



A03-5167ES

A04-7167ES

2-Drawer



AE-SK02S



A03-7178ES

A04-7178ES

3-Drawer



AE-SK08



A03-7167ES

A04-7B167ES

3-Drawer

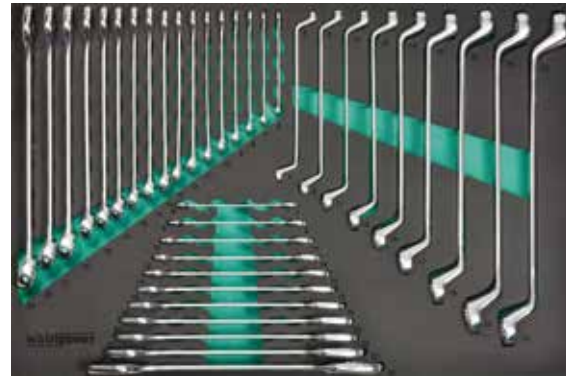

AE-WR02



A04-7B178ES

A04-8178ES

4-Drawer



AE-IS01



A04-8167ES

4-Drawer



AE-PL01

6-Drawer Tool Trolley, 182pcs

1-Drawer



AE-SD05

5-Drawer



AE-WR04

5-Drawer EVA Tool Trolley, 167pcs

1-Drawer



AE-SD02

5-Drawer



AE-TK04

2-Drawer



AE-SK03S

6-Drawer



AE-TK04





A03-7209ES

A04-7209ES

3-Drawer



AE-IS02



A03-7226ES

A04-7226ES

3-Drawer



AE-WR03



A04-7B209ES

A04-8209ES

4-Drawer



AE-AU07



A04-7B226ES

A04-8226ES

4-Drawer



AE-WR04

6-Drawer Tool Trolley, 209pcs

1-Drawer



AE-PL01

5-Drawer

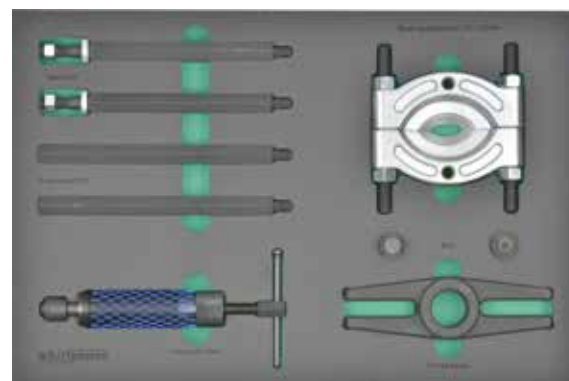

AE-AU06

6-Drawer Tool Trolley, 226pcs

1-Drawer



AE-SK04S

5-Drawer



AE-TK02

2-Drawer

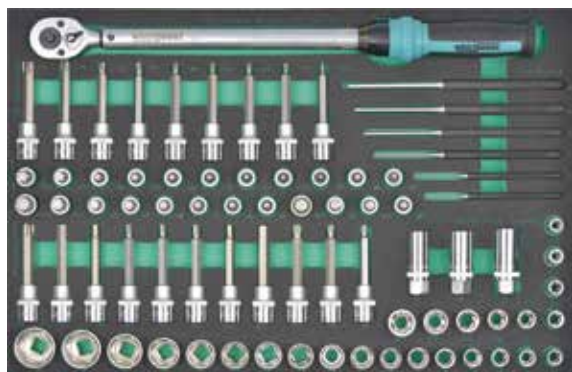

AE-SK05S

6-Drawer

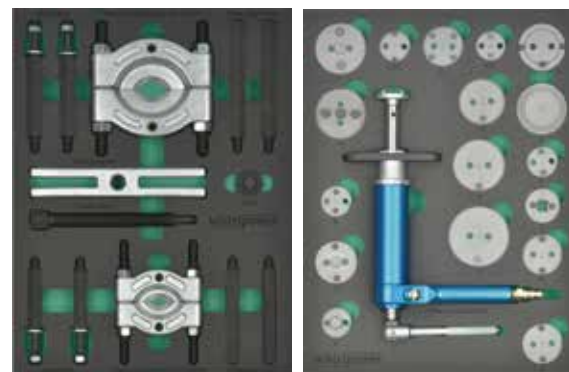

AE-AU05

AE-AU09

2-Drawer



AE-SK03S

6-Drawer



AE-TK03



MOBILE CABINET SET



A03-7256ES



A04-7256ES

3-Drawer

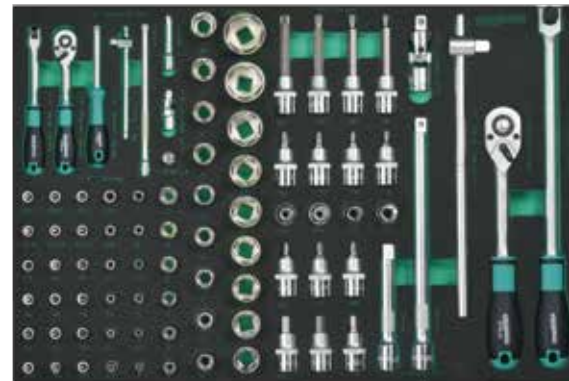

AE-SK07S



A03-7162ES



A04-7162ES

3-Drawer

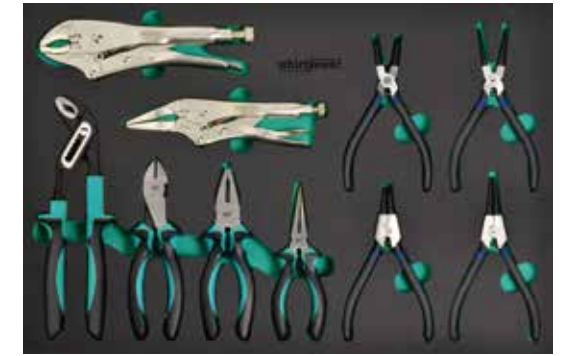

AE-PL01



A04-7B256ES



A04-8256ES

4-Drawer



AE-WR04



A04-7B162ES



A04-8162ES

4-Drawer

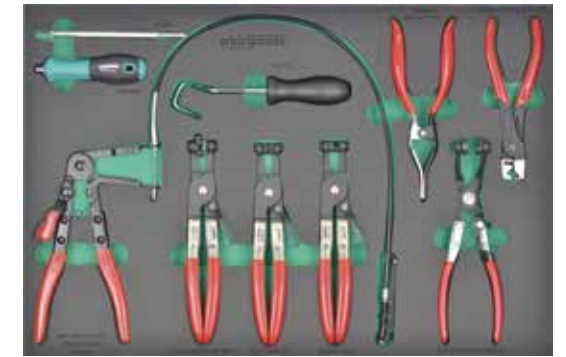

AE-AU03

6-Drawer Tool Trolley, 256pcs

1-Drawer



AE-SD04

5-Drawer



AE-WR05

7-Drawer Tool Trolley, 162pcs

1-Drawer

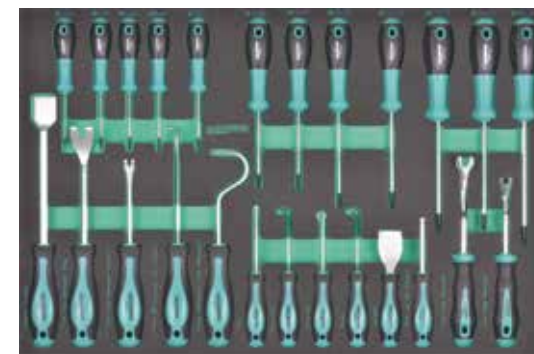

AE-SD03

5-Drawer



AE-AT01

2-Drawer



AE-PL01

6-Drawer



AE-IS02

2-Drawer



AE-SK03S

6-Drawer



AE-TK03

7-Drawer



AE-AT02

AE-AU04



AE-SD01

Screwdriver And Pliers Set, 13pcs



(L) 575 x (W) 375 x (H) 33 mm



Series	Contents	Weight
1 15602-211	Long Nose Pliers, 160mm	1.75kg
1 15604-21	Heavy Duty Diagonal Cutting Nippers, 180mm	
1 15608-02	Water Pump Pliers, 250mm	
2	Stubby Screwdrivers	
1711-7	⊖ 5.5x25	
1712-6	⊕ 2x25	
8	Screwdrivers	
S111-4	⊖ 6.5x150, 8.0x150	
S111-6	⊖ 2.5x75, 3.0x75, 3.5x100, 4.0x100	
S112-4	⊕ 1x80, 2x100	

AE-SD02

Screwdriver Set(Go-Thru), 31pcs



(L) 575 x (W) 375 x (H) 33 mm



Series	Contents	Weight
9 1588-1	Extra Long Ballpoint Hex Key Set, 9pcs(158-0709)	2.85kg
2	⊕ 1.5, 2, 2.5, 3, 4, 5, 6, 8, 10 Stubby Screwdrivers	
1711-7	⊖ 5.5x25	
1712-6	⊕ 2x25	
20	Screwdrivers	
S111-5	⊖ 5.5x125, 6.5x150, 8.0x175 10.0x200, 12.0x200	
S111-6	⊖ 3.0x75, 4.0x100	
S112-5	⊕ 1x80, 2x100, 3x150	
S114	⊕ 6, 7, 8, 9, 10, 15, 20, 25, 27, 30	

AE-SD03

File And Engine Tools, 25pcs



(L) 575 x (W) 375 x (H) 33 mm

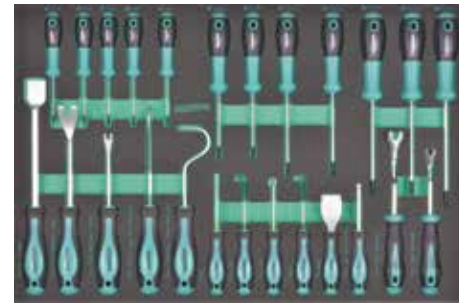

Series	Contents	Weight
1 15409-1	Pick 90° (Cotter Pin Puller), 235mm	1.81kg
1 15409-3	Hook (Radiator Hose Remover), 210mm	
2 15409-4	Gasket Scraper, 125, 270mm	
1 15409-5	Trim Pad Remover (Big), 235mm	
1 15409-6	Trim Pad Remover (Small), 200mm	
1 15409-2	Hook, 147mm	
1 15409-7	Pick, 147mm	
1 15409-8	Pick 45°, 147mm	
1 15409-9	Pick 90°, 147mm	
1 15409-11	140-430mm Pick Tool	
2 17109-11	Trim Pad Remover, 180, 200mm	
12 S114	⊕ 5, 6, 7, 8, 9, 10, 15, 20, 25, 27, 30, 40	

AE-SD04

Screwdriver Set, 30pcs



(L) 575 x (W) 375 x (H) 33 mm



Series	Contents	Weight
5 S111-3	⊖ 3.0x75, 4.0x100, 5.5x125, 6.5x150, 8.0x175	2.6kg
4 S112-3	⊕ 0x60, 1x80, 2x100, 3x150	
9 S114	⊕ 6, 8, 10, 15, 20, 25, 27, 30, 40	
8 S117-1	⊖ 6, 7, 8, 9, 10, 11, 12, 13	
2 1711-7	⊖ 5.5x25, 6.5x25	
2 1712-6	⊕ 1x25, 2x25	

AE-SD05

Screwdriver And Pliers Set(Go-Thru), 13pcs



(L) 575 x (W) 375 x (H) 33 mm



Series	Contents	Weight
1 15602-211	Long Nose Pliers, 160mm	1.75kg
1 15604-21	Heavy Duty Diagonal Cutting Nippers, 180mm	
1 15608-02	Water Pump Pliers, 250mm	
2	Stubby Screwdrivers	
1711-7	⊖ 5.5x25	
1712-6	⊕ 2x25	
4	Go-Thru Screwdrivers	
S111-5	⊖ 6.5x150, 8.0x150	
S112-5	⊕ 1x80, 2x100	
4	Screwdrivers	
S111-6	⊖ 2.5x75, 3.0x75, 3.5x100, 4.0x100	

AE-PL01

Pliers Set, 10pcs



(L) 575 x (W) 375 x (H) 33 mm



Series	Contents	Weight
1 15601-321	Combination Pliers, 180mm	2.88kg
1 15602-211	Long Nose Pliers, 160mm	
1 15604-21	Heavy Duty Diagonal Cutting Nippers, 180mm	
1 15608-02	Water Pump Pliers, 250mm	
1 15618-01	Circlip Pliers External Straight Nose, 178mm	
1 15618-02	Circlip Pliers External Bent Nose, 178mm	
1 15618-03	Circlip Pliers Internal Straight Nose, 168mm	
1 15618-04	Circlip Pliers Internal Bent Nose, 165mm	
1 16421-1	Curved Jaw Locking Pliers, 224mm	
1 16422-1	Long Nose Locking Pliers, 217mm	

AE-WR01

Wrench Set, 26pcs



(L) 575 x (W) 375 x (H) 33 mm



Series	Contents	Weight
17 1242-1	Combination Wrenches 6, 7, 8, 9, 10, 11, 12, 13, 14, 15, 16, 17 18, 19, 21, 22, 24mm	3.72kg
9 1243-1	Double Ring Deep Wrenches 6x7, 8x9, 10x11, 12x13, 14x15, 16x17 18x19, 20x22, 21x23mm	

AE-WR02

Wrench Tool Set, 37pcs



(L) 575 x (W) 375 x (H) 33 mm

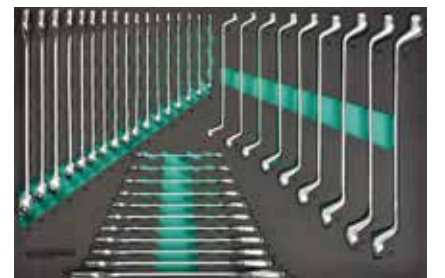

Series	Contents	Weight
11 1241-1	Double Open End Wrenches 6x7, 8x9, 10x11, 12x13, 14x15, 16x17 18x19, 20x22, 21x23, 24x27, 30x32mm	5.57kg
17 1242-1	Combination Wrenches 6, 7, 8, 9, 10, 11, 12, 13, 14, 15 16, 17, 18, 19, 21, 22, 24mm	
9 1243-1	Double Ring Deep Wrenches 6x7, 8x9, 10x11, 12x13, 14x15 16x17, 18x19, 20x22, 21x23mm	

AE-WR03

Wrench And Pliers Set, 25pcs



(L) 575 x (W) 375 x (H) 33 mm



Series	Contents	Weight
21 1242-1	Combination Wrenches 6, 7, 8, 9, 10, 11, 12, 13, 14, 15, 16, 17, 18, 19, 20, 21, 22, 24, 27, 30, 32mm	4.46kg
1 15601-321	Combination Pliers, 180mm	
1 15602-211	Long Nose Pliers, 200mm	
1 15604-12	Diagonal Cutting Nippers, 160mm	
1 15606	Wire Stripper, 180mm	

AE-WR04

Wrench Set, 31pcs

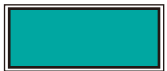

(L) 575 x (W) 375 x (H) 33 mm



Series	Contents	Weight
8 1241-1	Double Open End Wrenches 6x7, 8x9, 10x11, 12x13, 14x15, 16x17, 18x19, 20x22mm	5kg
8 1243-1	Double Ring Deep Wrenches 6x7, 8x9, 10x11, 12x13, 14x15, 16x17, 18x19, 20x22mm	
15 1638-1	Banlin Combination Wrenches 8, 10, 11, 13, 14, 15, 16, 18, 19, 21, 22, 24, 26, 27, 32mm	

AE-WR05

Wrenches Set, 32pcs



(L) 575 x (W) 375 x (H) 33 mm

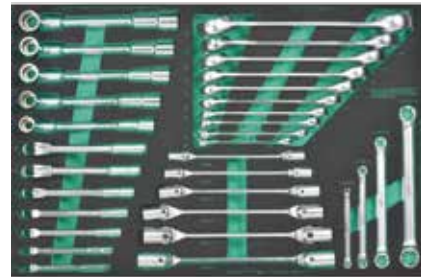

Series	Contents	Weight
4 1243-5	Double Ring Torqs Wrenches, straight E6xE8, E10xE12, E14xE18, E16xE22	6.5kg
12 1244-42	Double Ended Angled Socket Wrenches 8, 9, 10, 11, 12, 13, 14, 15, 16, 17, 18, 19mm	
6 1244-43	Double Hinged Socket Wrenches 8x9, 10x11, 12x13, 14x15, 16x17, 18x19, Flare Nut Wrenches	
10 1245-51	Flare Nut Wrenches 8x10, 10x11, 11x13, 12x14, 16x17, 18x19, 19x22, 22x24, 24x27, 30x32mm	

AE-SK01S

Socket Set, 56pcs



(L) 575 x (W) 375 x (H) 33 mm



Series	Contents	Weight
12 16121-11	1/4" Sockets, 6-Point 4, 5, 5.5, 6, 7, 8, 9, 10, 11, 12, 13, 14mm	4.89kg
1 16122-04	1/4" Ratchet Handle, 36T	
2 16123-02	1/4" Extension Bars, 55, 150mm	
1 16124-01	1/4" Sliding T Bar, 115mm	
1 16124-04	1/4" Spinner Handle, 145mm	
1 16125-01	1/4" Universal Joint, 40mm	
12 16127-11	1/4" Bit Sockets, 32mm 3.5, 5.5, 8.0	
16127-21	1, 2	
16127-31	1, 2	
16127-61	3, 4, 5, 6, 8	
21 16141-11	1/2" Sockets, 6-Point 10, 11, 12, 13, 14, 15, 16, 17, 18, 19, 20, 21, 22, 23, 24, 26, 27, 28, 30, 32, 34mm	
1 16142-02	1/2" Ratchet Handle, 36T	
2 16143-02	1/2" Extension Bars, 125, 250mm	
1 16144-01	1/2" Sliding T Bar, 300mm	
1 16145-02	1/2" Universal Joint, 78mm	

AE-SK02S

Socket Set, 78pcs



(L) 575 x (W) 375 x (H) 33 mm



Series	Contents	Weight
2 12743-22	1/2" Wheel Nut Impact Deep Sockets, 17, 19mm	6.09kg
12 16121-11	1/4" Sockets, 6-Point 4, 5, 5.5, 6, 7, 8, 9, 10, 11, 12, 13, 14mm	
11 16121-12	1/4" Deep Sockets, 6-Point 4, 5, 5.5, 6, 7, 8, 9, 10, 11, 12, 13mm	
1 16122-04	1/4" Ratchet Handle, 36T	
2 16123-02	1/4" Extension Bars, 55, 150mm	
1 16124-01	1/4" Sliding T Bar, 115mm	
1 16124-04	1/4" Spinner Handle, 145mm	
1 16125-01	1/4" Universal Joint, 40mm	
1 16125-04	3/8" x 1/4" Adapter	
1 16125-08	1/4" Magnetic Socket	
12 16127-11	1/4" Bit Sockets, 32mm 3.0, 5.5, 8.0	
16127-21	1, 2	
16127-31	1, 2	
16127-61	3, 4, 5, 6, 8	
17 16141-11	1/2" Sockets, 6-Point 10, 11, 12, 13, 14, 15, 16, 17, 18, 19, 20, 21, 22, 24, 27, 30, 32mm	
1 16142-02	1/2" Ratchet Handle, 36T	
1 16143-01	1/2" Wobble Extension Bar, 50mm	
2 16143-02	1/2" Extension Bars, 125, 250mm	
1 16144-01	1/2" Sliding T Bar, 300mm	
1 16145-02	1/2" Universal Joint, 78mm	
2 16145-03	3/8" x 1/2" Adapter, 3/4" x 1/2" Adapter	
8 16147-61	1/2" Bit Sockets, 55mm 5, 6, 7, 8, 10, 12, 14, 17	

AE-SK03S

Socket And Tool Set, 65pcs



(L) 575 x (W) 375 x (H) 33 mm



Series	Contents	Weight
1 1248-7	Specialist Series Adjustable Wrench, 203mm	7.56kg
1 1586-1	Extra Long Hex Key Wrench, 12mm	
9 1586-1	Extra Long Hex Key Set, 9pcs(158-0109) 1.5, 2, 2.5, 3, 4, 5, 6, 8, 10	
9 1586-1	Extra Long Hex Key Set (SAE), 9pcs(158-0209) 1/16", 5/64", 3/32", 1/8", 5/32", 3/16", 1/4", 5/16", 3/8"	
21 16141-11	1/2" Sockets, 6-Point 10, 11, 12, 13, 14, 15, 16, 17, 18, 19, 20, 21, 22, 23, 24, 25, 26, 27, 28, 30, 32mm	
16 16141-21	1/2" SAE Socket, 6-point 7/16", 1/2", 9/16", 19/32", 5/8", 11/16", 3/4", 25/32", 13/16", 7/8", 15/16", 1", 1-1/16", 1-1/8", 1-3/16", 1-1/4"	
1 16142-02	1/2" Ratchet Handle, 36T	
2 16143-02	1/2" Extension Bars, 125, 250mm	
1 16144-01	1/2" Sliding T Bar, 250mm	
1 16145-02	1/2" Universal Joint, 78mm	
2 16148-1	1/2" Spark Plug Socket, 16, 21mm	
1 16421-1	Curved Jaw Locking Pliers, 187mm	



AE-SK04S

Socket And Tool Set, 81pcs $\frac{1}{4}$ " $\frac{1}{2}$ "



(L) 575 x (W) 375 x (H) 33 mm



Series	Contents	Weight
5	138-0305 Chisel Punches Set, 5pcs	3.38kg
3	158-161 Short Hex Key, 1.5, 2.0, 2.5mm	
13	16121-11 $\frac{1}{4}$ " Sockets, 6-Point 4, 4.5, 5, 5.5, 6, 7, 8, 9, 10, 11, 12, 13, 14mm	
4	16121-12 $\frac{1}{4}$ " Deep Sockets, 6-Point, 8, 10, 11, 13mm	
1	16122-04 $\frac{1}{4}$ " Ratchet Handle, 36T	
2	16123-02 $\frac{1}{4}$ " Extension Bars, 55, 150mm	
1	16124-01 $\frac{1}{4}$ " Sliding T Bar, 115mm	
1	16124-04 $\frac{1}{4}$ " Spinner Handle, 145mm	
1	16125-01 $\frac{1}{4}$ " Universal Joint, 40mm	
21	16127-11 $\frac{1}{4}$ " Bit Sockets, 32mm ⊖ 4.0, 5.5, 6.5	
	16127-21 ⊕ 1, 2, 3	
	16127-31 ⊕ 1, 2, 3	
	16127-41 ⊕ 10, 15, 20, 25, 30, 40	
	16127-61 ● 3, 4, 5, 6, 7, 8	
15	16131-11 $\frac{3}{8}$ " Sockets, 6-Point 10, 11, 12, 13, 14, 15, 16, 17, 18, 19, 20, 21, 22, 23, 24mm	
1	16135-04 $\frac{1}{2}$ " \square x $\frac{3}{8}$ " \square Adapter	
1	16144-04 $\frac{1}{2}$ " Speedy Driver, 395mm	
4	174-0104 External Pliers, Bent Nose, 75mm External Pliers, Straight Nose, 75mm Internal Pliers, Bent Nose, 75mm Internal Pliers, Straight Nose, 75mm	
1	G015-06 Feeler Gauges, 26pcs	
1	G016-07 Metric Screw Pitch Gauges	
6	Screwdrivers	
	S111-3 ⊖ 3.0x75, 4.0x100	
	S111-4 ⊖ 5.5x125, 6.5x150	
	S112-4 ⊕ 1x80, 2x100	

AE-SK05S

Socket Set, 79pcs $\frac{1}{2}$ "



(L) 575 x (W) 375 x (H) 33 mm

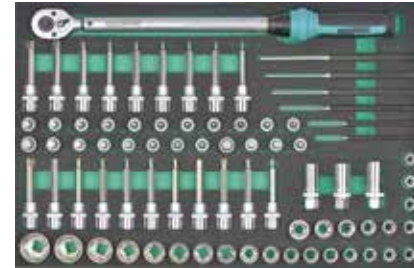

Series	Contents	Weight
1	168-6 $\frac{1}{2}$ " Torque Wrench, 40-210Nm	8.75kg
6	1382-03 Pin Punches, 2, 3, 4, 5, 6, 8mm	
3	16148-1 $\frac{1}{2}$ " Spark Plug Sockets, 16, 18, 21mm	
23	16147-41 $\frac{1}{2}$ " Bit Sockets, 55mm ⊕ 20, 25, 27, 30, 40, 45, 50, 55, 60	
	16147-61 ● 5, 6, 7, 8, 9, 10, 12, 14	
	16147-81 ● 5, 6, 8, 10, 12, 14	
29	16147-41 $\frac{1}{2}$ " Bit Sockets, 100 ⊕ 20, 25, 27, 30, 40, 45, 50, 55, 60	
	16147-61 ● 5, 6, 7, 8, 10, 12	
	16147-81 ● 6, 8, 10, 12, 14	
	16141-31 $\frac{1}{2}$ " Torqs Sockets, E10, E11, E12, E14, E16, E18, E20, E22, E24	
17	16141-11 $\frac{1}{2}$ " Sockets, 6-Point 10, 11, 12, 13, 14, 15, 16, 17, 18, 19, 20, 21, 22, 24, 27, 30, 32mm	

AE-SK06S

Socket Set, 79pcs $\frac{1}{2}$ "



(L) 575 x (W) 375 x (H) 33 mm



Series	Contents	Weight
1	1681-20 $\frac{1}{2}$ " Torque Wrench, 40-200Nm	8.8kg
6	1382-03 Pin Punches, 2, 3, 4, 5, 6, 8mm	
3	16148-1 $\frac{1}{2}$ " Spark Plug Sockets, 16, 18, 21mm	
23	16147-41 $\frac{1}{2}$ " Bit Sockets, 55mm ⊕ 20, 25, 27, 30, 40, 45, 50, 55, 60	
	16147-61 ● 5, 6, 7, 8, 9, 10, 12, 14	
	16147-81 ● 5, 6, 8, 10, 12, 14	
29	16147-41 $\frac{1}{2}$ " Bit Sockets, ⊕ 20, 25, 27, 30, 40, 45, 50, 55, 60	
	16147-61 ● 5, 6, 7, 8, 10, 12	
	16147-81 ● 6, 8, 10, 12, 14	
	16141-31 $\frac{1}{2}$ " Torqs Sockets, E10, E11, E12, E14, E16, E18, E20, E22, E24	
17	16141-11 $\frac{1}{2}$ " Sockets, 6-Point 10, 11, 12, 13, 14, 15, 16, 17, 18, 19, 20, 21, 22, 24, 27, 30, 32mm	

AE-SK07S

Socket Set, 86pcs $\frac{1}{4}$ " $\frac{1}{2}$ "



(L) 575 x (W) 375 x (H) 33 mm

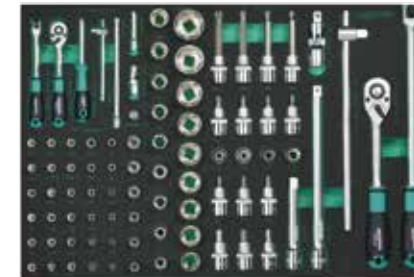

Series	Contents	Weight
12	16121-11 $\frac{1}{4}$ " Sockets, 6-Point 4, 4.5, 5, 5.5, 6, 7, 8, 9, 10, 11, 12, 13mm	6.7kg
6	16121-31 $\frac{1}{4}$ " Torqs Sockets, 25mm E4, E5, E6, E7 E8, E10	
1	16122-04 $\frac{1}{4}$ " Ratchet Handle, 36T	
1	16122-18 $\frac{1}{4}$ " Swivel Handle	
2	16123-02 $\frac{1}{4}$ " Extension Bar, 55, 150mm	
1	16124-01 $\frac{1}{4}$ " Sliding T Bar, 115mm	
1	16124-04 $\frac{1}{4}$ " Spinner Handle, 145mm	
1	16125-01 $\frac{1}{4}$ " Universal Joint, 40mm	
1	16125-04 $\frac{3}{8}$ " \square x $\frac{1}{4}$ " \square Adapter	
18	16127-11 $\frac{1}{4}$ " Bit Sockets, TX, 32mm ⊖ 4.0, 5.5, 6.5	
	16127-21 ⊕ 1, 2, 3	
	16127-41 ⊕ 8, 10, 15, 20, 25, 30, 40	
	16127-61 ● 3, 4, 5, 6, 8	
18	16141-11 $\frac{1}{2}$ " Sockets, 6-Point 10, 11, 12, 13, 14, 15, 16, 17, 18, 19, 20, 21, 22, 23, 24, 27, 30, 32mm	
4	16141-31 $\frac{1}{2}$ " Torqs Sockets, 25mm E10, E11, E12, E14	
1	16142-02 $\frac{1}{2}$ " Ratchet Handle, 36T	
1	16142-11 $\frac{1}{2}$ " Swivel Handle	
2	16143-02 $\frac{1}{2}$ " Extension Bars, 125, 250mm	
1	16144-01 $\frac{1}{2}$ " Sliding T Bar, 300mm	
1	16145-02 $\frac{1}{2}$ " Universal Joint, 78mm	
10	16147-41 $\frac{1}{2}$ " Bit Sockets, 55mm ⊕ 30, 40, 45, 50	
	16147-61 ● 6, 7, 8, 9, 10, 12	
4	16147-81 $\frac{1}{2}$ " Bit Sockets, 100mm ● 6, 8, 10, 12	

AE-SK08

Socket Set, 32pcs $\frac{3}{4}$ "



(L) 575 x (W) 375 x (H) 33 mm



Series	Contents	Weight
14	16161-11 $\frac{3}{4}$ " Sockets, 6-Point 19, 21, 22, 24, 27, 30, 32, 33, 34, 36, 38, 41, 46, 50mm	17.2kg
14	16161-21 $\frac{3}{4}$ " SAE Sockets, 6-Point 7/8", 15/16", 1", 1-1/16", 1-1/8", 1-3/16", 1-1/4", 1-5/16", 1-3/8", 1-7/16", 1-1/2", 1-5/8", 1-3/4", 1-7/8"	
1	16162-03 $\frac{3}{4}$ " Ratchet Handle, 24 teeth	
1	16162-06 $\frac{3}{4}$ " Swivel Handle	
1	16163-01 $\frac{3}{4}$ " Extension Bars, 400mm	
1	16164-01 $\frac{3}{4}$ " Sliding T Bar, 460mm	

AE-TK01

Tool Set, 22pcs



(L) 575 x (W) 375 x (H) 33 mm



Series	Contents	Weight
1	959-6 1Kg Flexible Claw Pick-Up Tool, 400mm	3.27kg
2	1382-01 Flat Chisel, 15, 25mm	
4	1382-03 Pin Punch, 3, 4, 5, 6mm	
1	1382-05 Center Punch, 6mm	
1	1383-81 Engineer's Hammer, 500g	
1	1384-85 Interchangeable-tip Mallets, 32mm	
1	15409-4 Gasket Scraper, 270mm	
9	1588-1 Extra Long Ballpoint Hex Key Set, 9pcs(158-0709) ● 1.5, 2, 2.5, 3, 4, 5, 6, 8, 10	
1	G015-05 20 Sizes Metric Feeler Gauges(0.05~1.00mm)	
1	G018-09 3M Metric Tape Ruler	

AE-TK02

Tool Set, 8pcs



(L) 575 x (W) 375 x (H) 33 mm



Series	Contents	Weight
1 1383-82	Ball Peen Hammer, 225g	2.28kg
5	Files, 200mm	
15407-1	Flat	
15407-2	Half-Round	
15407-3	Round	
15407-4	Triangle	
15407-5	Square	
1 C021-01	Hacksaw W12 Blade, 400mm	
1 U022-03	Strap Wrench, 225mm	

AE-TK03

Cup Type Oil Filter Wrench Set, 16pcs ^{3/8"}



(L) 575 x (W) 375 x (H) 33 mm



Contents	Weight
1 66mm (2-19/32")-6 Flutes	2.49kg
1 74-76mm (2-29/32" To 3")-15 Flutes	
1 76mm (3")-8 Flutes	
1 76mm (3")-12 Flutes	
1 76mm (3")-14 Flutes	
1 86mm (3-3/8")-16 Flutes	
1 86mm (3-3/8")-18 Flutes	
1 92mm (3-40/64")-10 Flutes	
1 93mm (3-21/32")-15 Flutes	
1 93mm (3-21/32")-45 Flutes	
1 96mm (3-3/4")-18 Flutes	
1 106mm (4-11/64")-15 Flutes	
1 108mm (4-8/32")-15 Flutes	
1 108mm (4-8/32")-18 Flutes	
1 3/8" x 1/2" Adapter	
1 3-Claw Oil Filter Wrench, 65-120mm	

AE-TK04

Tool Set, 11pcs



(L) 575 x (W) 375 x (H) 33 mm



Series	Contents	Weight
1 15407-1	Flat Files, 200mm	2.9kg
1 15407-2	Half-Round Files, 200mm	
1 15407-3	Round Files, 200mm	
1 15407-4	Triangle Files, 200mm	
1 15619-04	Straight Shears, 265mm	
1 C021-01	Hacksaw W/12" Blade	
1 G011-02	Straight Ruler, 300mm	
1 G015-06	Feeler Gauges, 26 Sizes (SAE 0.002" ~ 0.025" and Metric 0.05~0.63mm)	
1 G017-01	Vernier Caliper, 150mm	
1 G018-09	5M Metric Tape Ruler	
1 M064-01	Rechargeable Working Light	

AE-IS01

Impact Socket Set, 33pcs ^{3/4"}



(L) 575 x (W) 375 x (H) 33 mm



Series	Contents	Weight
15 12762-21	3/4" Impact Deep Sockets, 6-Point 19, 21, 22, 23, 24, 27, 28, 30, 32, 33, 34, 36, 38, 41, 46mm	19kg
14 12762-62	3/4" Impact Deep Sockets, 6-Point 19, 21, 22, 23, 24, 27, 30, 32, 33, 34, 36, 38, 41, 46mm	
1 12762-81	3/4" Impact Universal Joint	
2 12762-83	Impact Adapter, 1/2" x 3/4", 1" x 3/4"	
1 12762-92	3/4" Impact Extension Bar, 175mm	

AE-IS02

Impact Socket Set, 67pcs ^{3/8"} ^{1/2"}



(L) 575 x (W) 375 x (H) 33 mm



Series	Contents	Weight
11 12732-51	3/8" Impact Sockets, 6-Point 8, 10, 11, 12, 13, 14, 15, 16, 17, 18, 19mm	9.45kg
9 12732-62	3/8" Impact Deep Sockets, 6-Point 8, 10, 11, 12, 13, 14, 16, 17, 19mm	
1 12732-81	3/8" Impact Universal Joint	
2 12732-83	Impact Adapter, 1/4" x 3/8", 1/2" x 3/8"	
1 12732-91	3/8" Impact Extension Bar, 75mm	
19 12742-61	1/2" Impact Sockets, 6-Point 8, 10, 11, 12, 13, 14, 15, 16, 17, 18, 19, 20, 21, 22, 23, 24, 27, 30, 32mm	
18 12742-62	1/2" Impact Deep Sockets, 6-Point 10, 11, 12, 13, 14, 15, 16, 17, 18, 19, 20, 21, 22, 23, 24, 27, 30, 32mm	
1 12742-81	1/2" Impact Universal Joint	
2 12742-83	Impact Adapter, 3/8" x 1/2", 3/4" x 1/2"	
3 12742-91	1/2" Impact Extension Bar, 75, 125, 250mm	

AE-AT01

Universal Radiator Pressure Test Kit, 19pcs



(L) 575 x (W) 375 x (H) 40 mm



Contents	Weight
1 Pressure Pump	2kg
1 Thermometer	
1 Wrench for adapter	
2 Radiator Cap Test Tubers : 123/R124 (Black), R123/R125 (Blue)	
4 Steel Test Caps : No. 2 - No.5	
10 Nylon Test Adapter : No. 6 - No.15 Suitable for Acura, Alfa Romeo, Audi, BMW, Buick, Caterham, Citroën, Chrysler, Chevrolet, Dodge, FIAT, Ford, Geo, GM, Hummer, Honda, Hyundai, Infiniti, Isuzu, Jeep, Jaguar, Kia, Land Rover, Lexus, Lincoln, Mazda, Mercedes Benz, Mercury, Mitsubishi, Nissan, Opel, Oldsmobile, Peugeot, Plymouth, Pontiac, Porsche, Renault, Rover, Saab, Saturn, Scion, Škoda, Ssangyong, Sterling, Subaru, Seat, Suzuki, Toyota, VW	

AE-AT02

Gasoline Compression Tester, 8pcs



(L) 287 x (W) 375 x (H) 33 mm



Contents	Weight
1 Gauge	760g
1 Rubber Hose	
2 Test Tube : Straight, Angled	
4 Test Adapters : H13, Male thread 5/16"x 32 UNEF M10 x P1.0, M12 x P1.25, M14 x P1.25, M18 x P1.5	

AE-AU03

Hose Clamp Pliers Set, 10pcs



(L) 575 x (W) 375 x (H) 33 mm

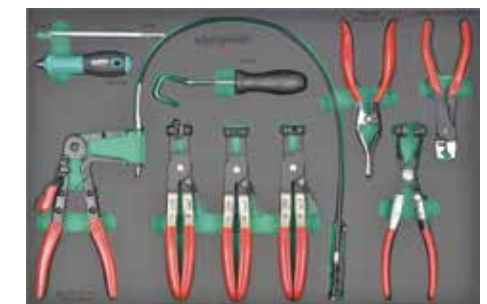

Contents	Weight
1 Wire Hose Clamp Pliers	2.45kg
1 360° CLIC Hose Clamp Pliers	
1 Flat Band Hose Clamp Pliers	
1 Flexible Hose Clamp Pliers	
1 Vacuum Hose Pliers, 5/32"~1/2"	
2 Bit Holder Screwdriver, BIT : PH2-SL6.0x120mm	
1 Curved Hose Clamp Pliers	
1 CLIC Hose Clamp Pliers	
1 Hook (Radiator Hose Remover)	



AE-AU04

Windscreen Removal Tool Set, 9pcs



(L) 287 x (W) 375 x (H) 33 mm



Contents

📦:2.3kg

- 1 Braided Wire (3 Strand)
- 1 T-Handle Wire Starter Tool
- 2 Wire Gripping Handles
- 2 Cold Knife Blade
- 1 Windscreen Removal Tool
- 1 Windshield Molding Release Tool
- 1 Trim Pad Remover

AE-AU05

Combination Gear And Bearing Separator, 12pcs



(L) 287 x (W) 375 x (H) 33 mm



Contents

📦:4.5kg

- 1 Bearing Separator and Bolts
Capacity Range: 30~50mm
Bolt : 3/8" x L120mm x 24t
- 1 Bearing Separator and Bolts
Capacity Range: 50~75mm
Bolt : 1/2" x L135mm x 20t
- 4 Main Rod
Hex Bar 17mm 3/8" x L125mm x 16t
- 4 Extension Rod
Hex Bar 14mm 3/8" x L110mm x 16t
- 1 Centre Bolt
5/8" x L175 x 18t/inch
- 1 Beam

AE-AU06

Hydraulic Gear & Bearing Split Tools, 8pcs



(L) 575 x (W) 375 x (H) 33 mm

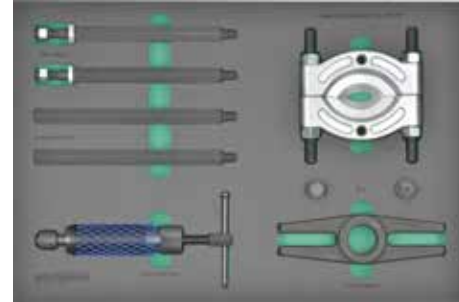

Contents

📦:8.2kg

- 1 Hydraulic Ram
Ø37.7mm x L168 x 1" 16t
- 1 Bearing Separator and Bolts
Capacity Range: 75~105mm
Bolt : 5/8" x 18nc x L165mm Ø16mm
- 2 Main Rod
Hex Bar 19mm x L10" x 1/2" 13nc
- 2 Extension Rod
Hex Bar 19mm x L10" x 1/2" 13nc
- 1 Beam
- 1 Centre Bolt

AE-AU07

High Quality Brake Tool Set, 15pcs ^{3/8"}



(L) 575 x (W) 375 x (H) 33 mm



Contents

📦:2.35kg

- 1 Flare Nut Wrench, 45°Offset Ring, 10×11mm
- 1 Phillips Screwdriver with go-thru blade and metal cap,
⊕ 3×150mm
- 1 Brake Spring Compressor
- 3 3/8" Bit Sockets, ● 6, 7(110mm), 8(80mm)
- 1 Bit Sockets Universal Joint, ● 1/4"
- 2 Brake Calliper Brushes : Brass, Steel
- 2 Drum Brake Spring Pliers
- 1 Brake Cable Spring Pliers
- 1 Brake Calliper File
- 2 T-Handle :
Headlight Adjusting And Brake Spring Hook
Valae Core Tool

AE-AU08

Universal Caliper Wind Back set , 19pcs



(L) 287 x (W) 375 x (H) 33 mm



Contents

📦:1.98kg

- 2 Right And Left hand Bolt
- 2 Holder Plate : Normal & Half-round
- 15 Brake Piston Adapter
Suitable for Alfa Romeo, Audi, BMW, Citroen, FIAT, Ford, GM,
HONDA, ISUZU, Jaguar, MAZDA, Mercedes Benz, Mitsubishi,
NISSAN, Opel, PEUGEOT, Rover, SAAB, TOYOTA, VW

AE-AU09

Air Powered Brake Caliper Wind Back Tool Set , 18pcs



(L) 287 x (W) 375 x (H) 33 mm



Contents

📦:2.2kg

- 1 Piston Wind Back Tool
- 17 Brake Piston Adapter
Suitable for Alfa romeo, Audi, BMW, Citroen, Fiat, Ford, Gm,
Honda, Isuzu, Jaguar, Lancia, Mazda, Mercedes-Benz,
Mitsubishi, Nissan, Opel, Peugeot, Rover, Saab, Subaru, Toyota,
Volvo, VW





A21-3

3 Drawer - Portable Tool Chest

A convenient made to last tool chest designed for mobility and handling convenience. Ball bearing slides provide smooth operation.

Weight: 11.1kg

	Length mm	Width mm	Height mm	QTY
CHEST	521	256	300	
DRAWER	449	221	50	2
	449	221	68	1



A22-4

Cantilever Tool Box

A convenient made to last tool chest designed for mobility and handling convenience.

Weight: 5.4kg

	Length mm	Width mm	Height mm	QTY
CHEST	475	220	235	
	470	105	50	4



A24-1

Water Resistant Trolley Case

- Safe and firm case.
- Automatic air volume control.
- Lock catch.
- O-Ring sealed.
- Each corner with designed angle.
- Hand Trolley.
- Temperature rating -20° to 80°

Weight: 5.6 KGS

	Length mm	Width mm	Height mm	QTY
CHEST	560	355	295	
DRAWER	510	290	252	4



A23-1036

Tool Box Set, 36pcs

Series	Contents	Weight: 4.2kg
A23-1	380Wx178Dx145Hmm	
11 1242-1	Combination Wrenches 8, 9, 10, 11, 12, 13, 14, 15, 17, 19, 22mm	
5 138-0305	Chisel Punches Set, 5pcs	
1 1383-81	Engineer's Hammer, 300g	
1 15602-211	Long Nose Pliers, 200mm	
1 15604-21	Heavy Duty Diagonal Cutting Nippers, 180mm	
1 15612-02	Water Pump Pliers(Box joint), 240mm	
9 158-0509	Short Hex Key Set, 9pcs	
1 C021-02	Mini Hacksaw W/6" Blade	
1 G018-09	3M Metric Tape Ruler	
5	Screwdrivers	
S111-3	⊖ 4x100, 5.5x125, 6.5x150	
S112-3	⊕ 1x80, 2x100	

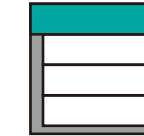

A21-3138S

Portable Tool Chest Set, 138pcs

1-Drawer



A-PA51S

2-Drawer



A-PA01

3-Drawer



A-PA02

4-Drawer



A-PA03



A-PA01

Tool Set, 26pcs $\frac{1}{2}$ "

(L) 445 x (W) 220 x (H) 30mm



Series	Contents	Weight: 2.6kg
1 15601-321	Combination Pliers, 180mm	
1 15602-211	Long Nose Pliers, 200mm	
1 15604-21	Heavy Duty Diagonal Cutting Nippers, 180mm	
1 16136-91	Adapter, 3/8"Dr.x5/16"Hex	
1 16145-05	Coupler, 5/16"x1/2"	
1 1711-7	Stubby Slotted Screwdriver ⊖ 5.5x25	
1 1712-6	Stubby Phillips Screwdriver ⊕ 2x25	
1 F011-01	1/2" Impact Driver	
4 F011-11	5/16" Bits, 36mm ⊖ 8.0, 10.0	
4 F011-21	⊕ 2, 3	
4 F011-12	5/16" Bits, 80mm ⊖ 8.0, 10.0	
4 F011-22	⊕ 2, 3	
5 F013-04	Extractor Bits, 1/8", 1/4", 5/16", 7/16", 9/16"	
2 S111-4	Slotted Screwdriver ⊖ 5.5x125, 6.5x150	
1 S111-6	Cabinet Tip Slotted Screwdriver ⊖ 4.0x100	
2 S112-4	Phillips Screwdriver ⊕ 1x80, 2x100	

A-PA02

Tool Set, 40pcs

(L) 445 x (W) 220 x (H) 30mm



Series	Contents	Weight: 3.8kg
16 1242-1	Combination Wrenches, 15° Offset Ring 6, 7, 8, 9, 10, 11, 12, 13, 14, 15, 16, 17, 18, 19, 22, 24mm	
2 1382-01	Flat Chisels, 12, 19mm	
1 1382-02	Cross Cut Chisel, 5mm	
2 1382-03	Pin Punches, 3, 4mm	
1 1382-05	Center Punch, 4mm	
9 1586-1	Extra Long Hex Key Set, 9pcs(158-0109) ● 1.5, 2, 2.5, 3, 4, 5, 6, 8, 10	
9 1584-2	Long Torqs Key Set, 9pcs(158-1209) ⊕ 10, 15, 20, 25, 27, 30, 40, 45, 50	

A-PA03

Tool Set, 8pcs

(L) 445 x (W) 220 x (H) 30mm



Series	Contents	Weight: 2.4kg
1 1249-3	Adjustable Wrenches, 250mm	
1 1383-81	Engineer's Hammer, 500g	
1 15612-02	Water Pump Pliers, 240mm	
1 16421-1	Curved Jaw Locking Pliers, 224mm	
1 C021-02	Mini Hacksaw W/6" Blade	
1 C022-03	Industrial Safety Utility Knife, 165mm	
1 C023-04	Scissors, 140mm	
1 G018-09	3M Metric Tape Ruler	

A-PA51S

Socket Set, 64pcs $\frac{1}{4}$ " $\frac{1}{2}$ "

(L) 500 x (W) 245 x (H) 60mm



Series	Contents	Weight: 5.3kg
12 16121-11	1/4" Sockets, 6-Point 4, 4.5, 5, 5.5, 6, 7, 8, 9, 10, 11, 12, 13mm	
1 16122-04	1/4" Ratchet Handle, 36T	
2 16123-02	1/4" Extension Bars, 55, 100mm	
1 16124-01	1/4" Sliding T Bar, 115mm	
1 16124-04	1/4" Spinner Handle, 145mm	
1 16125-01	1/4" Universal Joint, 40mm	
24 16127-11	1/4" Bit Sockets, 32mm ⊖ 4, 5.5, 6.5, 8	
16127-21	⊕ 1, 2, 3	
16127-31	⊕ 1, 2, 3	
16127-41	⊕ 8, 10, 15, 20, 25, 27, 30, 40	
16127-61	● 3, 4, 5, 6, 7, 8	
14 16141-11	1/2" Sockets, 6-Point 10, 11, 12, 13, 14, 15, 17, 19, 21, 22, 24, 27, 30, 32mm	
1 16142-02	1/2" Ratchet Handle, 36T	
1 16142-04	1/2" Swivel Handle, 450mm	
2 16143-02	1/2" Extension Bars, 125, 250mm	
1 16144-01	1/2" Sliding T Bar, 300mm	
1 16145-02	1/2" Universal Joint, 78mm	
2 16148-1	1/2" Spark Plug Sockets, 16, 21mm	



A22-4070S

Cantilever Tool Box Set, 70pcs

1-Tray



A-PB06



A-PB09S

2-Tray



A-PB02



A-PB03

3-Tray



A-PB51



C021-02



15409-4

A22-4072S

Cantilever Tool Box Set, 72pcs

1-Tray



SA-PB09S



A-PB05

2-Tray



A-PB07



A-PB01

3-Tray



A-PB03



A-PB04



A22-4071S

Cantilever Tool Box Set, 71pcs

1-Tray



A-PB09S



A-PB08

2-Tray



A-PB03



A-PB01

3-Tray



A-PB06



A-PB04

A-PB01

Go-thru Screwdriver Set, 6pcs

(L) 460 x (W) 100 x (H) 30mm



Series	Contents	Weight
3 S111-5	⊖ 5.5x125, 6.5x150, 8.0x175	⚖️:2.3kg
3 S112-5	⊕ 1x80, 2x100, 3x150	

A-PB02

Screwdriver Set, 11pcs

(L) 460 x (W) 100 x (H) 30mm



Series	Contents	Weight
2 1711-1	⊖ 5.5x25, 6.5x25	⚖️:0.6kg
2 1712-6	⊕ 1x25, 2x25	
2 S111-4	⊖ 5.5x125, 6.5x150	
2 S111-6	⊖ 3.0x75, 4.0x100	
1 S112-3	⊕ 0x60	
2 S112-4	⊕ 1x80, 2x100	

A-PB03

Pliers Set, 3pcs

(L) 460 x (W) 100 x (H) 30mm



Series	Contents	Weight
1 15601-321	Combination Pliers, 180mm	⚖️:0.9kg
1 15602-211	Long Nose Pliers, 200mm	
1 15604-21	Heavy Duty Diagonal Cutting Nippers, 180mm	

A-PB04

Tool Set, 4pcs

(L) 460 x (W) 100 x (H) 30mm



Series	Contents	Weight
1 1249-3	Adjustable Wrench, 250mm	⚖️:1.4kg
1 15409-4	Gasket Scraper, 270mm	
1 15612-02	Water Pump Pliers, 240mm	
1 16412-1	Curved Jaw Locking Pliers, 224mm	

A-PB05

Double Ring Deep 75° Offset Wrenches Set, 9pcs

(L) 460 x (W) 100 x (H) 30mm



Series	Contents	Weight
9 1243-1	6x7, 8x9, 10x11, 12x13, 14x15, 16x17, 18x19, 21x23, 24x27mm	⚖️:1.9kg

A-PB06

Combination Wrenches 15° Offset Ring Set, 15pcs

(L) 460 x (W) 100 x (H) 30mm



Series	Contents	Weight
15 1242-1	8, 10, 11, 12, 13, 14, 15, 16, 17, 18, 19, 21, 22, 23, 24 mm	⚖️:1.9kg

A-PB07

Double Open End Wrenches and Hex Key Set, 26pcs

(L) 460 x (W) 100 x (H) 30mm



Series	Contents	Weight
10 1241-1	Double Open End Wrenches 6x7, 8x9, 10x11, 12x13, 14x15, 16x17, 18x19, 20x22, 21x23, 24x27mm	⚖️:2.5kg
9 1588-1	Extra Long Ballpoint Hex Key Set, 9pcs(158-0709)	
7 16147-61	1/2" Bit Sockets, 55mm	

A-PB08

Double Open End Wrenches and Hex Key Set, 19pcs

(L) 460 x (W) 100 x (H) 30mm



Series	Contents	Weight
10 1241-1	Double Open End Wrenches 6x7, 8x9, 10x11, 12x13, 14x15, 16x17, 18x19, 20x22, 21x23, 24x27mm	⚖️:1.9kg
9 1588-1	Extra Long Ballpoint Hex Key Set, 9pcs(158-0709)	

A-PB09S

Socket Set, 24pcs 1/2"

(L) 460 x (W) 100 x (H) 30mm



Series	Contents	Weight
18 16141-11	1/2" Sockets, 6-Point 10, 11, 12, 13, 14, 15, 16, 17, 18, 19, 21, 22, 23, 24, 27, 28, 30, 32mm	⚖️:3.8kg
1 16142-02	1/2" Ratchet Handle, 36T	
3 16143-02	1/2" Extension Bars, 75, 125, 250mm	
1 16144-01	1/2" Sliding T Bar, 250mm	
1 16145-02	1/2" Universal Joint, 78mm	

A-PB51

Tool Set, 15pcs

(L) 460x (W) 210 x (H) 30mm



Series	Contents	Weight
1 1249-3	Adjustable Wrench, 250mm	⚖️:3.2kg
1 1382-01	Flat Chisel, 15mm	
1 1382-02	Cross Cut Chisel, 5mm	
3 1382-03	Pin Punches, 3, 4, 5mm	
2 1382-04	Taper Punches, 6, 8mm	
1 1382-05	Center Punch, 6mm	
1 1383-81	Engineer's Hammer 300g	
1 1384-85	Interchangeable-tip Mallets, 32mm	
1 15612-02	Water Pump Pliers, 240mm	
1 16421-1	Curved Jaw Locking Pliers, 224mm	
1 C022-03	Industrial Safety Utility Knife, 165mm	
1 G018-09	3M Metric Tape Ruler	



A22-4077S

Cantilever Tool Box Set, 77pcs 1/2"

Series	Contents	Weight: 18kg
1 959-6	1Kg Flexible Claw Pick-Up Tool, 400mm	
1 17107-6	Triangular Scraper, 250mm	
7	Screwdriver	
1 1711-7	⊖ 5.5x25	
1 1712-6	⊕ 2x25	
S111-3	⊖ 4.0x100	
S111-4	⊖ 6.5x125, 8.0x150	
S112-4	⊕ 2x100, 3x150	
1 1249-3	Adjustable Wrench, 250mm	
5 138-0305	Chisel Punches Set, 5pcs	
1 1383-81	Engineer's Hammer, 500g	
4	File, 200mm	
1 15407-1	Flat	
1 15407-2	Half-Round	
1 15407-3	Round	
1 15407-4	Triangle	
1 15601-321	Combination Pliers, 180mm	
1 15602-211	Long Nose Pliers, 160mm	
1 15604-21	Heavy Duty Diagonal Cutting Nippers, 180mm	
1 15612-02	Water Pump Pliers, 240mm	
1 15612-03	Pipe Wrench, 438mm	
1 15619-01	Aviation Snips, Left-Cut, 248mm	
8 1586-3	Short Hex Key Set, 8pcs(158-4908) ● 2, 2.5, 3, 4, 5, 6, 8, 10	
15 A-PB06	Combination Wrenches 15° Offset Ring Set, 15pcs	
24 A-PB09	1/2" Socket Set, 24pcs	
1 C021-02	Mini Hacksaw W/6" Blade	
1 C022-04	Foldable Knife, 210mm	
1 U034-01	Rolling Head Dry Bars, 470mm	
1 U041-02	Two-Jaw Gear Puller, 40-76mm	



A22-4085S

Cantilever Tool Box Set, 85pcs 1/2"

Series	Contents	Weight: 19kg
1 1241-1	Double Open End Wrenches, 30x32mm	
1 1243-1	Double Ring Wrenches, 30x32mm	
1 1248-2	Tyre Lever, 380mm	
2 1382-01	Flat Chisels, 15, 22mm	
1 1382-02	Cross Cut Chisels, 5mm	
2 1382-04	Taper Punches, 2, 4mm	
1 1382-05	Center Punch, 6mm	
1 1383-81	Engineer's Hammer, 500g	
1 1384-85	Interchangeable-tip Mallets, 32mm	
1 15409-4	Gasket Soraper, 270mm	
2 15612-01	Groove Joint Pliers, 200, 265mm	
4 16147-61	1/2" Bit Sockets, 55mm ● 5, 6, 8, 10	
3 A-PB03	Pliers Set, 3pcs	
9 A-PB05	Double Ring Deep 75° Offset Wrenches Set, 9pcs	
19 A-PB08	Double Open End Wrenches and Hex Key Set, 19pcs	
24 A-PB09	1/2" Socket Set, 24pcs	
1 G018-09	3M Metric Tape Ruler	
11	Screwdriver	
S111-3	⊖ 5.5x125, 8.0x175	
S111-6	⊖ 2.5x75, 3.0x75, 3.5x100, 4.0x100	
S112-3	⊕ 1x80, 2x100, 3x150	
S113-3	⊕ 1x80, 2x100	



- Heavy duty water-resistance Polyester fabric.
- Adjustable padded shoulder strap included.
- Outside tape holder and level fixture.
- Steel tube with foam for comfortable grip.
- Velcro attached fabric cover for shelter, can be used for kneel protection during job.
- Patented Two layer structure, upper layer for bigger & heavier tools, low bottom for small components storage.
- Size : 46 x 26 x 32cm , N.W.: 2.8 KGS



A25-1071S

Tote Tool Bag Set, 71pcs 1/2"

Series	Contents	Weight: 12.4kg
1 959-6	1Kg Flexible Claw Pick-Up Tool, 400mm	
15 1242-1	Combination Wrenches 7, 8, 9, 10, 11, 12, 13, 14, 15 16 17, 18, 19, 22, 24mm	
1 1382-01	Flat Chisel, 12mm	
1 1382-02	Cross Cut Chisel, 5mm	
2 1382-03	Pin Punches, 2, 4mm	
2 1382-04	Taper Punches, 2, 4mm	
1 1382-05	Center Punch, 4mm	
1 1383-81	Engineer Hammer, 500g	
1 1384-85	Interchangeable-tip Mallets, 32mm	
1 15601-321	Combination Pliers, 180mm	
1 15602-211	Long Nose Pliers, 200mm	
1 15604-12	Diagonal Cutting Nippers, 160mm	
1 15612-02	Water Pump Pliers, 240mm	
8 1586-3	Short Hex Key Set, 8pcs(158-4908) ● 2, 2.5, 3, 4, 5, 6, 8, 10	
1 16421-1	Curved Jaw Locking Pliers, 224mm	
13 16141-11	1/2" Sockets, 6-Point 10, 11, 12, 13, 14, 15, 17, 19, 22, 24, 27, 30, 32mm	
1 16142-02	1/2" Ratchet Handle, 36T	
2 16143-02	1/2" Extension Bars, 125, 250mm	
1 16145-02	1/2" Universal Joint, 78mm	
1 16135-05	3/8" 3-way Adapter, 1/2" x3/8" □	
1 C021-01	Hacksaw W/12" Blade	
1 C022-03	Industrial Safety Utility Knife, 165mm	
1 C023-04	Scissors, 140mm	
1 G018-09	3M Metric Tape Ruler	
1 M051-01	Voltage Tester, 120-250V	
8	Screwdrivers	
S111-4	⊖ 5.5x125, 6.5x150, 8.0x175	
S111-6	⊖ 3.0x75, 4.0x100	
S112-3	⊕ 0x60	
S112-4	⊕ 1x80, 2x100	
2	Insulated Screwdrivers	
V111	⊖ 4.0x100	
V112	⊕ 1x80	



A25-2109S

Tote Tool Bag Set, 109pcs

Weight: 14.3kg

Series	Contents
1 959-6	1Kg Flexible Claw Pick-Up Tool, 400mm
15 1242-1	Combination Wrenches 7, 8, 9, 10, 11, 12, 13, 14, 15 16 17, 18, 19, 22, 24mm
1 1249-3	Adjustable Wrench, 250mm
1 1382-01	Flat Chisel, 12mm
1 1382-02	Cross Cut Chisel, 5mm
2 1382-03	Pin Punches, 2, 4mm
2 1382-04	Taper Punches, 2, 4mm
1 1382-05	Center Punch, 4mm
1 1383-85	Riveting Hammer, 30mm
1 1384-85	Interchangeable-tip Mallets, 32mm
1 15601-321	Combination Pliers, 180mm
1 15602-211	Long Nose Pliers, 200mm
1 15604-12	Diagonal Cutting Nippers, 160mm
1 15612-02	Water Pump Pliers, 240mm
1 15618-02	Circlip Pliers External Bent Nose, 178mm
1 15618-04	Circlip Pliers Internal Bent Nose, 165mm
9 1586-3	Short Hex Key Set, 9pcs(158-5509) ● 1.5, 2, 2.5, 3, 4, 5, 6, 8, 10
3 1586-3	Short Hex key Wrenches, 3pcs
12 16121-11	1/4"Socket, 6-Point 4, 4.5, 5, 5.5, 6, 7, 8, 9, 10, 11, 12, 13mm
1 16122-04	1/4" Ratchet Handle, 36T
2 16123-02	1/4" Extension Bar, 55, 100mm
1 16124-01	1/4"Sliding T Bar, 115mm
1 16124-04	1/4"Spinner Handle, 145mm
1 16125-01	1/4"Universal Joint, 40mm
12 16127-11	1/4" Bit Sockets, 32mm ⊖ 3, 4, 5.5, 6.5, 8
16127-21	⊕ 1, 2
16127-61	● 3, 4, 5, 6, 8
1 16135-05	3-Way Adapter, 1/2" x 3/8" □
13 16141-11	1/2" Sockets, 6-Point 10, 11, 12, 13, 14, 15, 17, 19, 22, 24, 27, 30, 32mm
1 16142-02	1/2" Ratchet Handle, 36T
2 16143-02	1/2" Extension Bars, 125, 250mm
1 16145-02	1/2" Universal Joint, 78mm
1 16421-1	Curved Jaw Locking Pliers, 224mm
1 C021-01	Hacksaw W/12" Blade
1 C022-03	Industrial Safety Utility Knife, 165mm
1 C022-04	Foldable Knife, 210mm
1 C023-04	Scissors, 140mm
1 G018-09	3M Metric Tape Ruler
1 M051-01	Voltage Tester, 120-250V
8	Screwdrivers
S111-4	⊖ 5.5x125, 6.5x150, 8.0x175
S111-6	⊖ 3.0x75, 4.0x100
S112-3	⊕ 0x60
S112-4	⊕ 1x80, 2x100
2	Insulated Screwdrivers
V111	⊖ 4.0x100
V112	⊕ 1x80



A25-3107S

Tote Tool Bag Set, 107pcs

Weight: 11.4kg

Series	Contents
1 959-6	1Kg Flexible Claw Pick-Up Tool, 400mm
15 1242-1	Combination Wrenches 7, 8, 9, 10, 11, 12, 13, 14, 15 16 17, 18, 19, 22, 24mm
1 1382-01	Flat Chisel, 12mm
1 1382-02	Cross Cut Chisel, 5mm
2 1382-03	Pin Punches, 2, 4mm
2 1382-04	Taper Punches, 2, 4mm
1 1382-05	Center Punch, 4mm
1 1383-85	Riveting Hammer, 30mm
1 1384-85	Interchangeable-tip Mallets, 32mm
1 15409-4	Gasket Scraoer, 125mm
1 15701-321	Insulated Combination Pliers, 180mm
1 15702-311	Insulated Long Nose Pliers, 200mm
1 15704-12	Insulated Diagonal Cutting Pliers, 160mm
1 15708-02	Insulated Water Pump Pliers, 250mm
9 1586-3	Short Hex Key Set, 9pcs(158-5509) ● 1.5, 2, 2.5, 3, 4, 5, 6, 8, 10
13 16121-11	1/4"Socket, 6-Point 4, 4.5, 5, 5.5, 6, 7, 8, 9, 10, 11, 12, 13, 14mm
7 16121-31	1/4"Torqs Sockets,6-Point E4, E5, E6, E7, E8, E10, E11
1 16122-04	1/4" Ratchet Handle, 36T
2 16123-02	1/4" Extension Bar, 55, 100mm
1 16124-01	1/4"Sliding T Bar, 115mm
1 16124-04	1/4"Spinner Handle, 145mm
1 16125-01	1/4"Universal Joint, 40mm
19 16127-11	1/4" Bit Sockets, 32mm ⊖ 4, 5.5, 6.5
16127-21	⊕ 1, 2, 3
16127-41	● 8, 10, 15, 20, 25, 27, 30, 40
16127-61	● 3, 4, 5, 6, 7
1 16421-1	Curved Jaw Locking Pliers, 224mm
1 1771-1	Crimping Pliers, 230mm
1 1777-3	Hand Cable Cutter, 160mm
1 C021-01	Hacksaw W/12" Blade
1 C022-03	Industrial Safety Utility Knife, 165mm
1 C022-04	Foldable Knife, 210mm
1 C023-04	Scissors, 140mm
1 G011-02	Straight Ruler, 300mm
1 G014-01	Horizontal Ruler, 300mm
1 G017-01	Vernier Caliper, 235mm
1 G018-09	Metric Tape Ruler, 3M
1 M041-01	Soldering Tin, 15g
1 M053-01	Voltage Tester with LED/LCD Display 100-690V
1 100-GH-150	Cordless Battery-Powered Soldering Iron
9	Insulated Screwdrivers
V111	⊖ 3.5x100, 4.0x100, 5.5x125, 6.5x150
V112	⊕ 0x60, 1x80, 2x100
V113	⊕ 1x80, 2x100



A26-1050S

Tote Tool Bag Set, 50pcs 3/8"

Size: 44 x 33 x 10cm



Series	Contents
9	1/4" Double Bit, 150mm
7411-11	⊖ 5.0 x ⊖ 6.5
7422-11	⊕ 1x⊕ 2
7433-11	⊕ 1x⊕ 2
7444-11	⊕ 10x⊕ 15
7444-11	⊕ 20x⊕ 25
7444-11	⊕ 30x⊕ 40
7468-11	● 4x ● 4
7468-11	● 5x ● 5
7468-11	● 6x ● 6
1 959-8	Interchangeable Screwdriver
9 1241-1	Double Open End Wrenches 6x7, 8x9, 10x11, 12x13, 14x15 16x17, 18x19, 21x23, 22x24mm
1 1249-3	Adjustable Wrenches, 250mm
1 1281-21	Wire Brush
1 1382-01	Flat Chisel, 12mm
1 1382-03	Pin Punch, 4mm
1 1382-85	Riveting Hammer, 30mm
1 15602-211	Long Nose Pliers, 200mm
1 15604-12	Diagonal Cutting Nippers, 160mm
1 15612-01	Groove Joint Pliers, 265mm
1 16421-1	Curved Jaw Locking Pliers, 224mm
13 16131-11	3/8" Sockets, 6-Point 8, 9, 10, 11, 12, 13, 14, 15, 16, 17, 18, 19, 21mm
1 16132-02	3/8" Ratchet Handle, 36T
2 16133-02	3/8" Extension Bars, 150, 250mm
1 16134-01	3/8" Sliding T Bar, 165mm
1 16135-01	3/8" Universal Joint, 55mm
2 16138-1	3/8" Spark Plug Sockets, 16, 21mm
1 G015-05	20 Sizes Metric Feeler Gauges(0.05~1.00mm)
1 U034-02	Power Levers, 300mm

A26-2046S

Tote Tool Bag Set, 46pcs ^{1/2"}

• Size : 44 x 33 x 10cm



Series	Contents	Weight: 7kg
11 1242-1	Combination Wrenches 6, 7, 8, 10, 11, 12, 13, 14, 15, 17, 19mm	
1 12743-5	Spark Plug Socket, 21mm	
1 1383-81	Engineer Hammer, 300g	
1 15601-321	Combination Pliers, 180mm	
1 15604-21	Heavy Duty Diagonal Cutting Nippers, 180mm	
1 15612-01	Groove Joint Pliers, 265mm	
8 1586-3	Short Hex Key Set, 8pcs(158-4908) ● 2, 2.5, 3, 4, 5, 6, 8, 10	
9 16141-11	1/2" Sockets, 6-Point 10, 11, 12, 13, 14, 15, 17, 19, 22mm	
1 16142-02	1/2" Ratchet Handle, 36T	
2 16143-02	1/2" Extension Bars, 125, 250mm	
1 16144-01	1/2" Sliding T Bar, 300mm	
1 16145-02	1/2" Universal Joint, 78mm	
1 M051-01	Voltage Tester, 120-250V	
1 M052-01	Circuit Tester, 6-24V	
5	Screwdrivers	
S111-3	⊖ 5.5x125, 6.5x150	
S111-6	⊖ 4.0x100	
S112-3	⊕ 1x80, 2x100	
1 V111	Insulated Screwdrivers ⊖ 3.0x100	

A27-1043

Tool Set, 43pcs



Series	Contents	Weight: 4.9kg
18	Bits, 25mm	
962-11	⊕ 1, 2	
963-11	⊕ 1, 2, 3	
964-11	⊕ 8, 9, 10, 15, 20, 25, 27, 30, 40	
966-11	● 3, 4, 5, 6	
4 1241-1	Double Open End Wrenches 8x10, 13x14, 17x19, 22x24mm	
1 1382-01	Flat Chisel, 15mm	
1 1383-81	Engineer's Hammer, 300g	
1 15601-321	Combination Pliers, 180mm	
1 15602-211	Long Nose Pliers, 160mm	
1 15604-12	Diagonal Cutting Nippers, 160mm	
1 15606	Wire Strippers, 180mm	
1 15608-02	Water Pump Pliers, 250mm	
9 1586-3	Short Hex Key Set, 9pcs(158-5509) ● 1.5, 2, 2.5, 3, 4, 5, 6, 8, 10	
1 C022-03	Industrial Safety Utility Knife, 165mm	
1 G014-01	Horizontal ruler, 300mm	
1 G018-09	3M Metric Tape Ruler	
1 M051-01	Voltage Tester, 120-250V	
1 S117-3	Bit Holding Screwdriver	

A24-1117S

4-Pallet Tool Case Set, 117pcs

1-Pallet



A-PC01

2-Pallet



A-PC05

3-Pallet



A-PC03S

4-Pallet



A-PC07



A24-1125S

4-Pallet Tool Case Set, 125pcs

1-Pallet



A-PC08

2-Pallet



A-PC06

3-Pallet

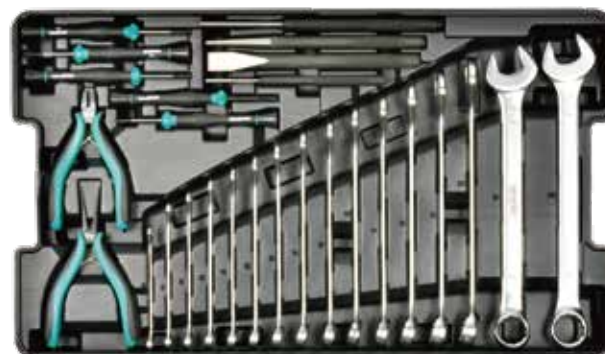

A-PC04

4-Pallet



A-PC02S



A-PC01

Tool Set, 12pcs



Series	Contents	Weight: 3.2kg
9 1243-1	Double Ring Wrenches, 75° Offset Ring 6x7, 8x9, 10x11, 12x13, 14x15, 16x17 18x19, 20x22, 21x23mm	
1 15602-211	Long Nose Pliers, 160mm	
1 15604-21	Heavy Duty Diagonal Cutting Nippers, 180mm	
1 15612-02	Water Pump Pliers, 240mm	

A-PC02S

Socket Set, 66pcs 1/4" 1/2"



Series	Contents	Weight: 5kg
23 961-11	1/4" Bit, 25mm	
962-11	⊖ 4.0, 5.5, 6.5	
963-11	⊕ 1, 2, 3	
964-11	⊕ 1, 2, 3	
966-11	⊕ 10, 15, 20, 25, 27, 30, 40	
969-3-11	● 3, 4, 5, 6	
969-3-11	● 5, 6, 8	
12 16121-11	1/4" Socket, 6-Point 4, 5, 5.5, 6, 7, 8, 9, 10, 11, 12, 13, 14mm	
1 16122-04	1/4" Ratchet Handle, 36T	
2 16123-02	1/4" Extension Bars, 55, 150mm	
1 16124-01	1/4" Sliding T Bar, 115mm	
1 16124-04	1/4" Spinner Handle, 145mm	
1 16125-01	1/4" Universal Joint, 40mm	
20 16141-11	1/2" Socket, 6-Point 10, 11, 12, 13, 14, 15, 16, 17, 18, 19, 20 21, 22, 23, 24, 26, 27, 28, 30, 32mm	
1 16142-02	1/2" Ratchet Handle, 36T	
2 16143-02	1/2" Extension Bars, 125, 250mm	
1 16144-01	1/2" Sliding T Bar, 300mm	
1 16145-02	1/2" Universal Joint, 78mm	

A-PC03S

Socket Set, 56pcs 1/4" 1/2"

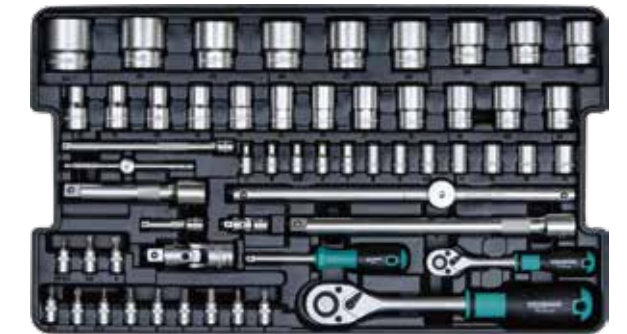

Series	Contents	Weight: 5.3kg
12 16121-11	1/4" Socket, 6-Point 4, 5, 5.5, 6, 7, 8, 9, 10, 11, 12, 13, 14mm	
1 16122-04	1/4" Ratchet Handle, 36T	
2 16123-02	1/4" Extension Bars, 55, 150mm	
1 16124-01	1/4" Sliding T Bar, 115mm	
1 16124-04	1/4" Spinner Handle, 145mm	
1 16125-01	1/4" Universal Joint, 40mm	
12 16127-11	1/4" Bit Sockets, 32mm ⊖ 3.5, 5.5, 8.0	
16127-21	⊕ 1, 2	
16127-31	⊕ 1, 2	
16127-61	● 3, 4, 5, 6, 8	
21 16141-11	1/2" Socket, 6-Point 10, 11, 12, 13, 14, 15, 16, 17, 18, 19, 20 21, 22, 23, 24, 26, 27, 28, 30, 32, 34mm	
1 16142-02	1/2" Ratchet Handle, 36T	
2 16143-02	1/2" Extension Bars, 125, 250mm	
1 16144-01	1/2" Sliding T Bar, 300mm	
1 16145-02	1/2" Universal Joint, 78mm	

A-PC04

Tool Set, 27pcs

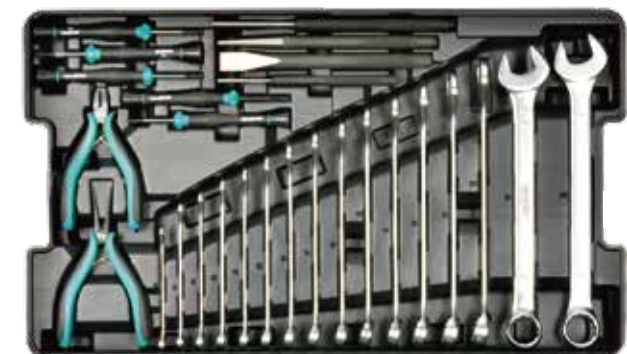

Series	Contents	Weight: 2.9kg
16 1242-1	Combination Wrenches, 15° Offset Ring 6, 8, 9, 10, 11, 12, 13, 14, 15, 16 17, 18, 19, 20, 21, 22mm	
3 1301	Screwdrivers ⊖ 1.2x40, 1.5x40, 2.0x40	
2 1302	⊕ 00x40, 0x40	
1 1382-01	Flat Chisel, 15mm	
2 1382-03	Pin Punches, 3, 5mm	
1 1382-05	Center Punch, 6mm	
1 1741-20	Diagonal Pliers, 4"	
1 1741-21	Long Nose Pliers, 4"	



A-PC05

Tool Set, 27pcs



Series	Contents	Weight: 3.4kg
17 1242-1	Combination Wrenches 6, 7, 8, 9, 10, 11, 12, 13, 14, 15, 16 17, 18, 19, 21, 22, 24mm	
1 1711-7	⊖ 5.5x25	
1 1712-6	⊕ 2x25	
2 S111-5	⊖ 6.5x150, 8.0x150	
4 S111-6	⊖ 2.5x75, 3.0x75, 3.5x100, 4.0x100	
2 S112-5	⊕ 1x80, 2x100	

A-PC07

Tool Set, 22pcs



Series	Contents	Weight: 8.5kg
1 959-6	1Kg Flexible Claw Pick-Up Tool, 400mm	
2 1382-01	Flat Chisels, 19, 25mm	
4 1382-03	Pin Punches, 3, 4, 5, 6mm	
1 1382-05	Center Punch, 6mm	
1 1383-81	Engineer's Hammer, 500g	
1 1384-85	Interchangeable-tip Mallets, 32mm	
1 15409-4	Gasket Scraper, 270mm	
9 1588-1	Extra Long Ballpoint Hex Key Set, 9pcs(158-0709) ● 1.5, 2, 2.5, 3, 4, 5, 6, 8, 10	
1 G015-05	20 Sizes Metric Feeler Gauges(0.05-1.00mm)	
1 G018-09	3M Metric Tape Ruler	

A-PC06

Tool Set, 19pcs



Series	Contents	Weight: 3kg
1 1383-81	Engineer's Hammer, 500g	
1 1384-85	Interchangeable-tip Mallets, 32mm	
1 15407-1	Flat Files, 200mm	
1 15407-3	Round Files, 200mm	
1 15407-4	Triangle Files, 200mm	
1 1586-3	Short Hex Key Wrenches, 1.3mm	
9 1586-3	Short Hex Key Set, 9pcs(158-0509) ● 1.5, 2, 2.5, 3, 4, 5, 6, 8, 10	
1 C021-02	Mini Hacksaw W/6" Blade	
1 F023-01	Oil Can, 150cc	
1 G017-01	Vernier Caliper, 150mm	
1 G019-11	Engineer Scriber, 225mm	

A-PC08

Tool Set, 13pcs

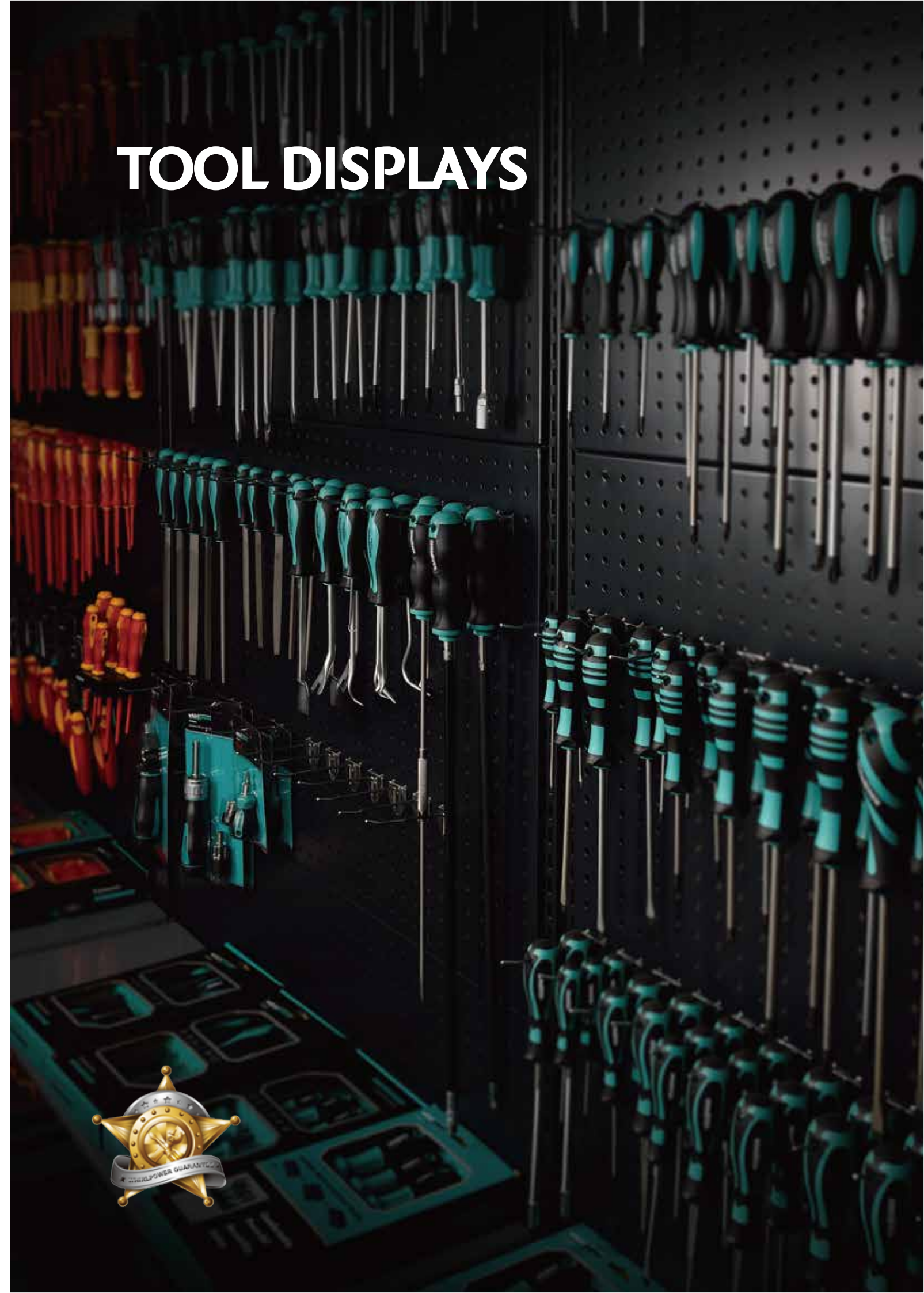

Series	Contents	Weight: 2.4kg
1 15609-11	Terminal Crimping Tool, 225mm, 0.5-16mm ²	
1 15701-321	Insulated Combination Pliers, 180mm	
1 15702-311	Insulated Long Nose Pliers, 200mm	
1 15704-12	Insulated Diagonal Cutting Pliers, 160mm	
1 C022-04	Foldable Knife, 210mm	
1 G018-09	3M Metric Tape Ruler	
1 M041-11	Desoldering Pump, 200mm	
1 M051-01	Voltage Tester, 120-250V	
1 M053-01	Voltage Tester With LED/LCD Display Insulated Screwdrivers	
2 V111	⊖ 4.0x100, 5.5x125	
2 V112	⊕ 1x80, 2x100	

TOOL DISPLAYS

SALES DISPLAY

We offer sales displays in several different formats.

1. SCREWDRIVER DISPLAY STAND

This is an ideal solution for Whirlpower's screwdrivers setting on cashier counter, suitable for both standard type and go-through type. The stands are for 50 pcs and 75 pcs, and can be customized.

2. TOOL DISPLAY RACK

Tool rack in two different sizes with Whirlpower Logo on top. Also suitable for set up in showroom or during exhibitions.

D01-03

Tool Display Rack

- Includes one modular shelf
- Four display board in each Display Rack set
- Material: Steel



Display Board x 4



W mm	L mm	Code	kg
952	2040	2040	49.6

D02-01

Tabletop Display Rack

- Material: Steel



W mm	L mm	Code	kg
373	695	695	5

D04-01

Screwdriver Display Stand

- 10 Rows with 5 Tools, total 50pcs
- Acrylic Pallet, EVA Feet



W mm	L mm	Code	g
315	435	435	1105

D04-02

Screwdriver Display Stand

- 15 Rows with 5 Tools, total 75pcs
- Acrylic Pallet, EVA Feet



W mm	L mm	Code	g
315	645	645	1560

D05-01

Screwdriver Shelf



W mm	D mm	H mm	Code	kg
450	270	45	450	1.56

D05-02

Socket Shelf

- Bracketx2, Septax18

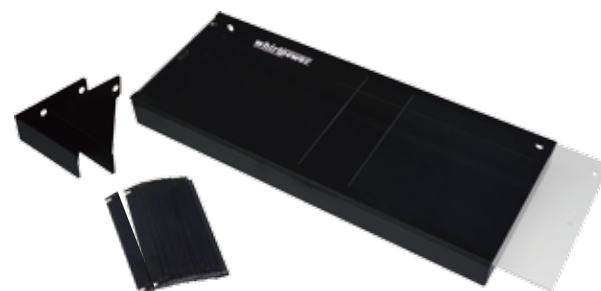

W mm	D mm	H mm	Code	kg
570	230	50	450	4.25

D06-01

Bit Display Hanger

- Fits logo plate in groove on display hanger
- Uses two hooks to hang display hanger set on racks



W mm	L mm	Code	g
90	520	402	520

D06-02

Bit Display Hanger

- Fits logo plate in groove on display hanger
- Uses two hooks to hang display hanger set on racks



W mm	L mm	Code	g
90	560	560	414

D07-01

Socket Display Stand



W mm	D mm	H mm	Code	g
583	110	445	583	8230

D01-SD02

Insulated Tool Kit, 25pcs

- Without Display Board

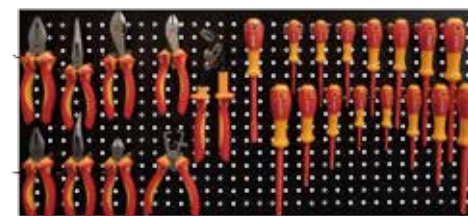

Series	Contents
2 15701-321	Combination Pliers, 180, 200mm
1 15702-311	Long Nose Pliers, 200mm
1 15703-311	Bent Nose Pliers, 200mm
1 15704-12	Diagonal Cutting Nippers, 160mm
2 15704-21	Heavy Duty Diagonal Cutting Nippers, 180, 200mm
1 15706	Wire Strippers, 180mm
1 15708-02	Water Pump Pliers, 250mm
16	Screwdrivers
V111	⊖ 2.5x75, 3x100, 3.5x100, 4x100, 5.5x125, 6.5x150, 8x175
V112	⊕ 0x60, 1x80, 2x100, 3x150
V113	⊕ 0x60, 1x80, 2x100, 3x150
V114	Insulated Bit Holding Screwdriver
	Display Board : 910x420mm

D01-SD01

File And Engine Tools, 22pcs

- Without Display Board

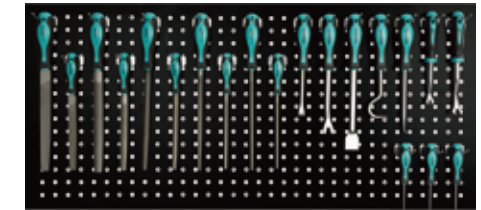

Series	Contents
2 15407-1	Flat Files, 150, 200mm
2 15407-2	Half-Round Files, 150, 200mm
2 15407-3	Round Files, 150, 200mm
2 15407-4	Triangle Files, 150, 200mm
2 15407-5	Square Files, 150, 200mm
1 15409-1	Pick 90° (Cotter Pin Puller), 235mm
1 15409-2	Hook, 147mm
1 15409-3	Hook (Radiator Hose Remover), 210mm
1 15409-4	Gasket Scraper, 270mm
1 15409-5	Trim Pad Remover (Big), 235mm
1 15409-6	Trim Pad Remover (Small), 200mm
1 15409-7	Pick, 147mm
1 15409-8	Pick 45°, 147mm
1 15409-9	Pick 90°, 147mm
2 17109-11	Trim Pad Remover, 180, 200mm
1 15409-11	140-430mm Pick Tool
	Display Board : 910x420mm

D01-PL01

Pliers Set, 18pcs

- Without Display Board

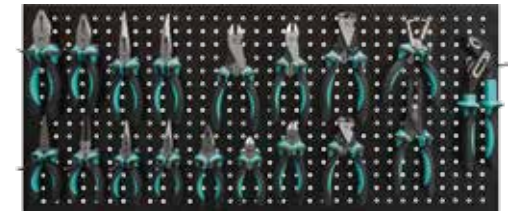

Series	Contents
3 15601-321	Combination Pliers, 160mm, 180mm, 200mm
1 15602-121	Flat Nose Pliers, 160mm
2 15602-211	Long Nose Plier, 160mm, 200mm
1 15602-133	Round Nose Pliers, 160mm
2 15603-211	Bent Nose Pliers, 160mm, 200mm
2 15604-12	Diagonal Cutting Nippers, 125mm, 160mm
2 15604-21	Heavy Duty Diagonal Cutting Nippers, 180mm, 200mm
2 15605-11	End Cutting Nippers, 160mm, 200mm
1 15606	Wire Strippers, 180mm
1 15608-02	Water Pump Pliers, 250mm
1 15609-11	Terminal Crimping Tool, 225mm
	Display Board : 910x420mm

D01-WR01

Double Open End Wrenches Set, 15pcs

- Without Display Board

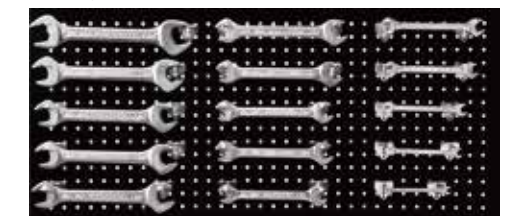

Series	Contents
15 1241-1	6x7, 8x9, 10x11, 12x13, 14x15, 16x17, 17x19, 18x19, 20x22, 21x23, 23x26, 24x26, 24x27, 25x28, 30x32mm
	Display Board : 910x420mm

ОФИЦИАЛЬНЫЙ ДИЛЕР В УКРАИНЕ:

storgom.ua

ГРАФИК РАБОТЫ:

Пн. – Пт.: с 8:30 по 18:30

Сб.: с 09:00 по 16:00

Вс.: с 10:00 по 16:00

КОНТАКТЫ:

+38 (044) 360-46-77

+38 (066) 77-395-77

+38 (097) 77-236-77

+38 (093) 360-46-77

Детальное описание товара: <https://storgom.ua/product/nabor-instrumentov-whirlpower-a04-7272s-232-3.html>

Другие товары: <https://storgom.ua/nabory-instrumentov.html>